

AMERIKAANS
WISSELSTROOM-SPOOR(STAAF) RELAIS
TWEEFASEN-MOTORRELAIS
FABRIKAAT G.R.S.

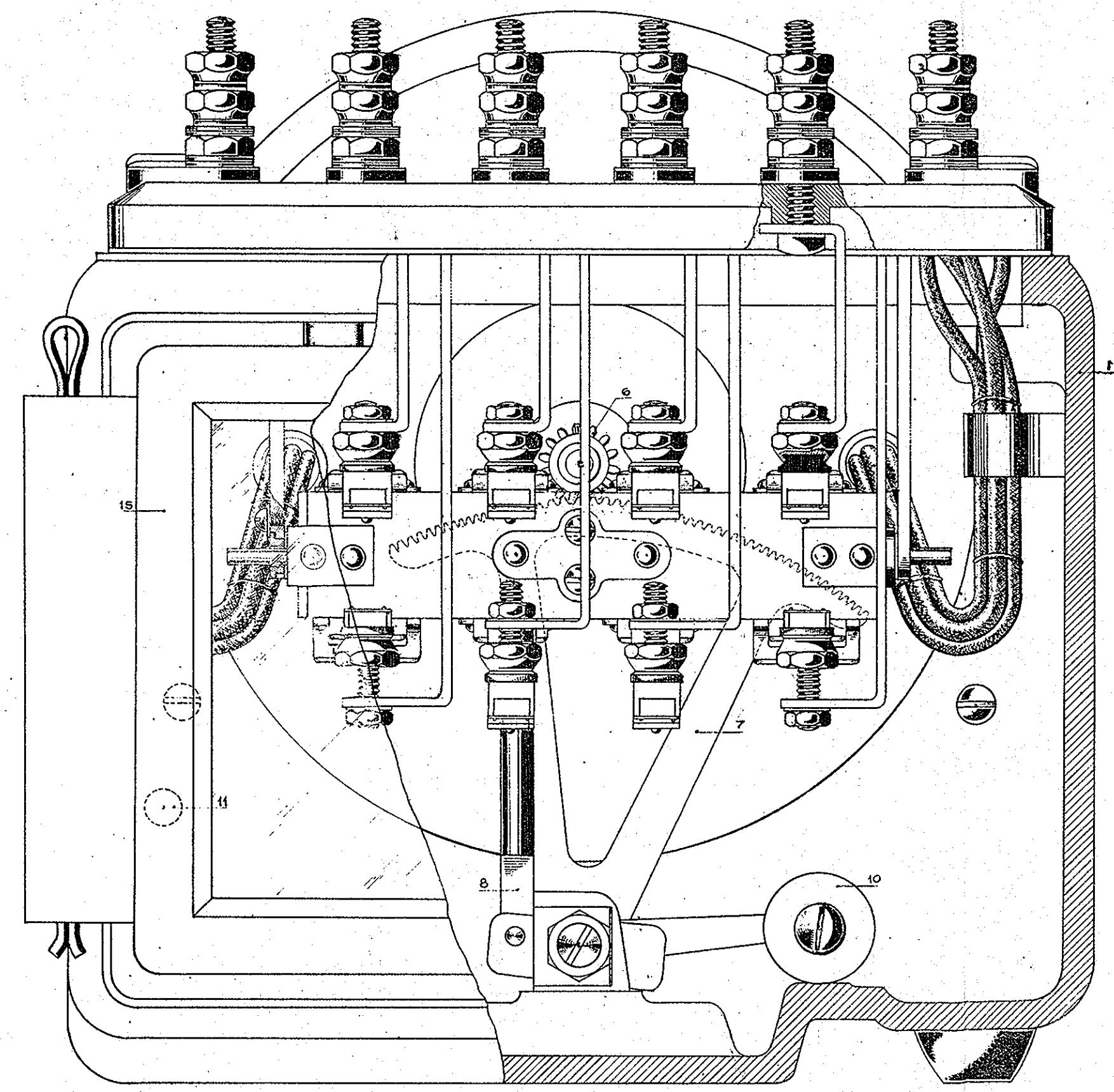

FIG 1^a

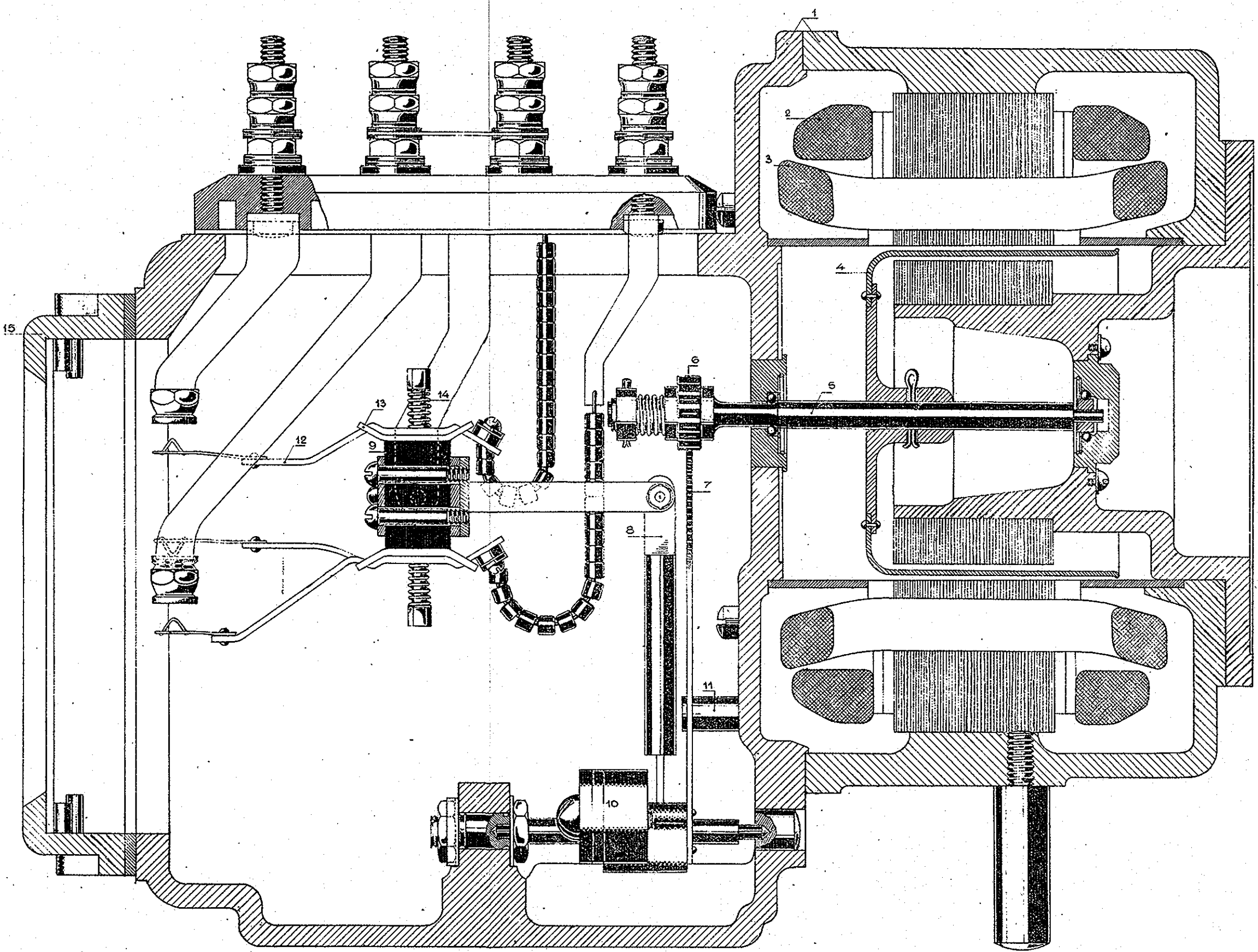

FIG 1^b

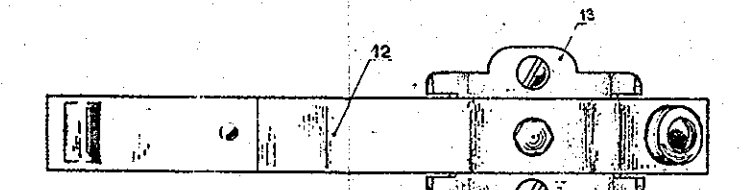

FIG 2^b

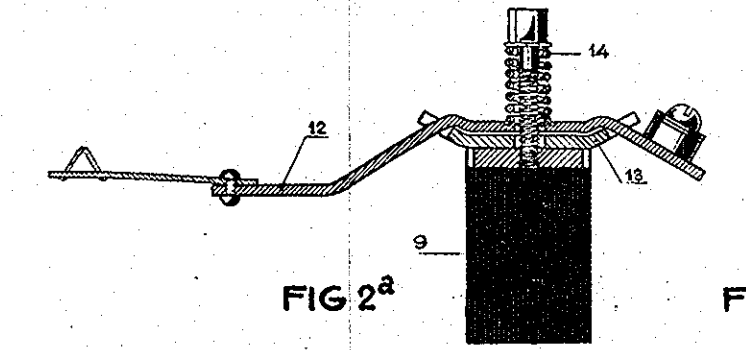

FIG 2^a

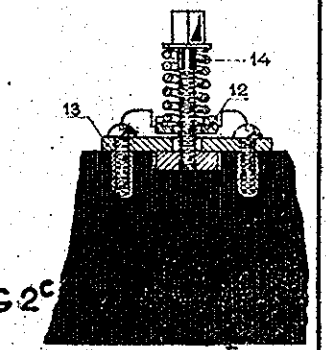

FIG 2^c

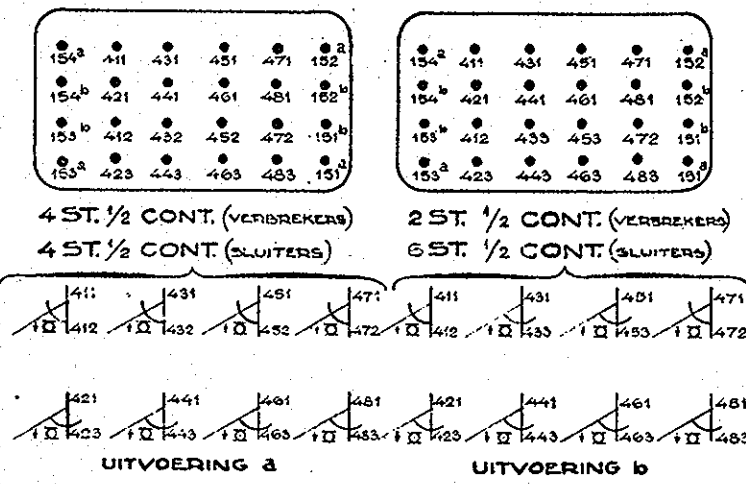

FIG 3

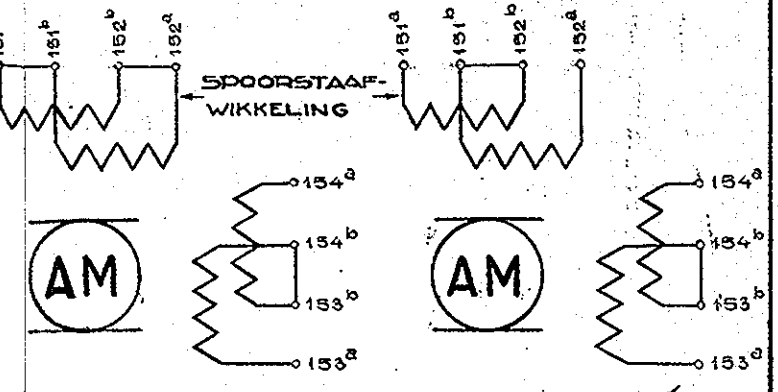

FIG 4

FIG 5

AMERIKAANS RELAI'S	AANTAL CONTACTEN NUMMER					4S+4V					
	154 ^a	154 ^b	153 ^b	153 ^a	151 ^a	1↑					
154 ^a 411 431 451 471 152 ^a	154 ^b 421 441 461 481 152 ^b	153 ^b 412 432 452 472 151 ^b	153 ^a 423 443 463 483 151 ^a			TRAFO 2 110V O-44202	O-44101	O	O	O	90201
							O-TRAFO 2 3V O-41101	O	O	O	O
							O-48202	O	O	O	O
							TRAFO 2 110V O-15102	O-901	O	O	90101

FIG 6