

A.I.C. TEST  
SECTION ONLY  
Do Not REMOVE

# TYPE B RELAYS

General Information  
Inspection and Maintenance

HANDBOOK 18



GRS



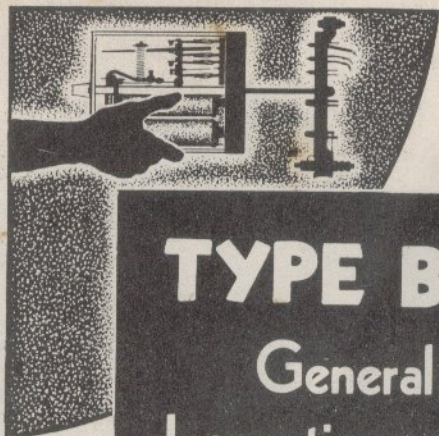

# TYPE B RELAYS

General Information  
Inspection and Maintenance

HANDBOOK 18

AUGUST 1940

*Supersedes Pamphlet 535*

**GENERAL RAILWAY SIGNAL COMPANY**

ROCHESTER, N. Y.



Copyright 1940  
General Railway Signal Company  
Rochester, New York

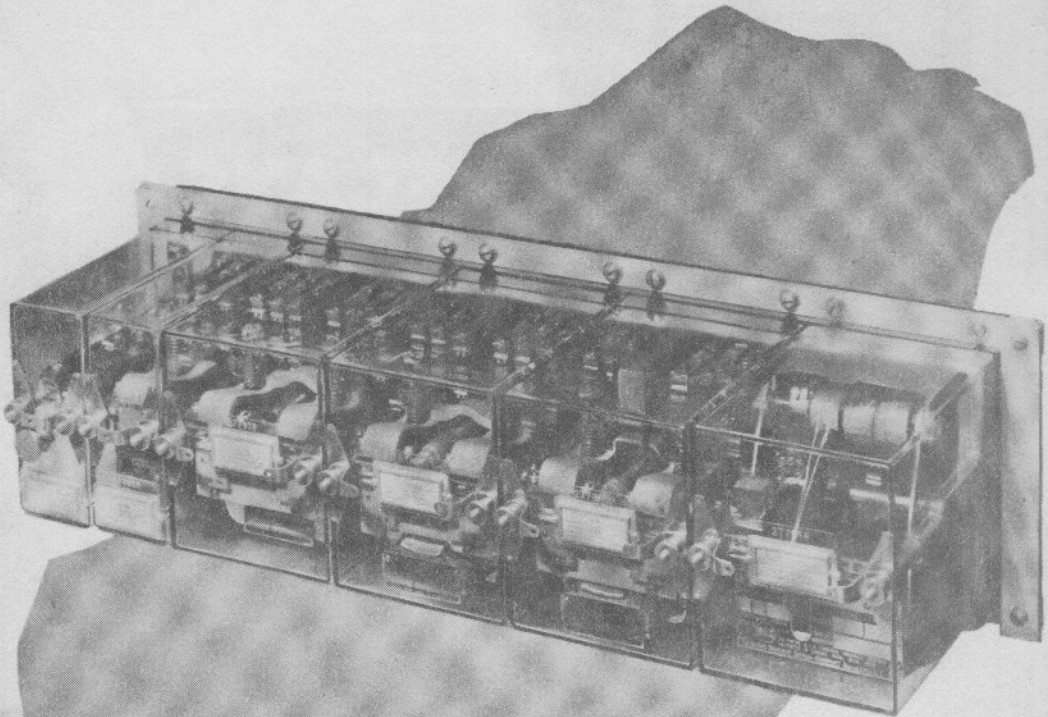

Figure 1

THE TYPE B LINE OF RELAYS

From left to right—

- Type B Size 1 Thermal Relay
- Type B Size 1 Neutral Relay
- Type B Size 2 Neutral Relay
- Type B Size 2 Neutral Polar Relay
- Type B Size 2 Retained-Neutral Polar Relay
- Type B Size 2 a-c. Vane Relay

Printed in U.S.A.

# CONTENTS

PAGE

## GENERAL INFORMATION

I.	GENERAL DESCRIPTION OF TYPE B RELAYS -----	7
II.	THE DIRECT-CURRENT RELAYS -----	17
	A. General Characteristics -----	17
	B. Theory of Operation of Neutral Polar Relays-----	17
	C. Theory of Operation of R-N-P Relays -----	21
	D. Contact Combination Capacity of D-c. Relays-----	23
	E. D-c. Relay Winding Combinations -----	27
	F. Test Terminals -----	29
III.	THE ALTERNATING-CURRENT RELAYS -----	31
	A. General Characteristics -----	31
	B. Contact Combination Capacity of A-c. Relays-----	33
	C. A-c. Relay Winding Combinations -----	35
	D. Test Terminals -----	36
IV.	THE THERMAL TIME-ELEMENT RELAYS -----	37
V.	QUICK-DETACHABLE FEATURE -----	43
VI.	INSPECTION -----	43
VII.	HOW TO PLUG IN A RELAY -----	45
VIII.	HOW TO REMOVE A RELAY -----	45
NOMENCLATURE AND WRITTEN CIRCUITS		
IX.	RELAY NOMENCLATURE -----	49
	A. Numbering the Contact Terminals -----	49
	B. Numbering the Winding Terminals -----	49
X.	WRITTEN CIRCUITS -----	51
	A. Contacts -----	51
	B. Windings -----	52

CONTENTS (continued)

PAGE

TESTS

XI.	TESTS -----	57
	A. With Relays on Relay Racks -----	57
	B. With Relays on Test Rack -----	59
	C. D-c. Test Board -----	61
	D. Tests for Relay Timing -----	63
	E. Electrical Tests on D-c. Relays -----	68
	1. Electrical Tests for Operating Values on Type B Sizes 1 and 2 Neutral Relays-	69
	2. Electrical Tests for Operating Values on Type B Size 2 Neutral Polar Relays--	70
	3. Electrical Tests for Operating Values on Type B Size 2 Retained-Neutral Polar Relays -----	71
	F. A-c. Test Board -----	73
	G. Electrical Tests on A-c. Relays -----	75
	1. Electrical Tests for Operating Values on Type B Two-Position Vane Relays ----	75
	2. Electrical Tests for Operating Values on Type B Three-Position Vane Relays --	76
	H. Electrical Tests on Thermal Relays -----	76
	J. Contact Resistance -----	77
	WIRING CHANGES, TOOLS, AND SUPPLIES	
XII.	SUGGESTIONS WHEN CHANGING PLUGBOARD WIRING ----	81
XIII.	TOOLS AND SUPPLIES -----	83

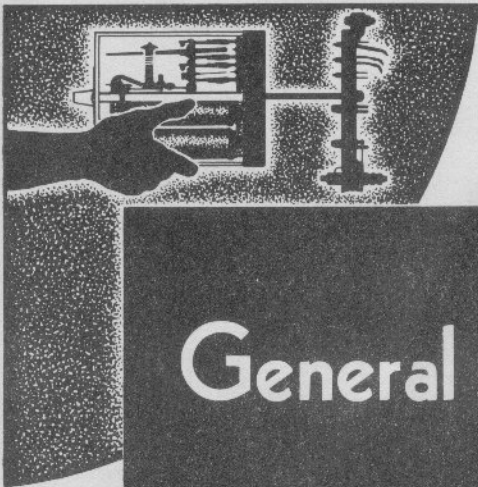

# General Information

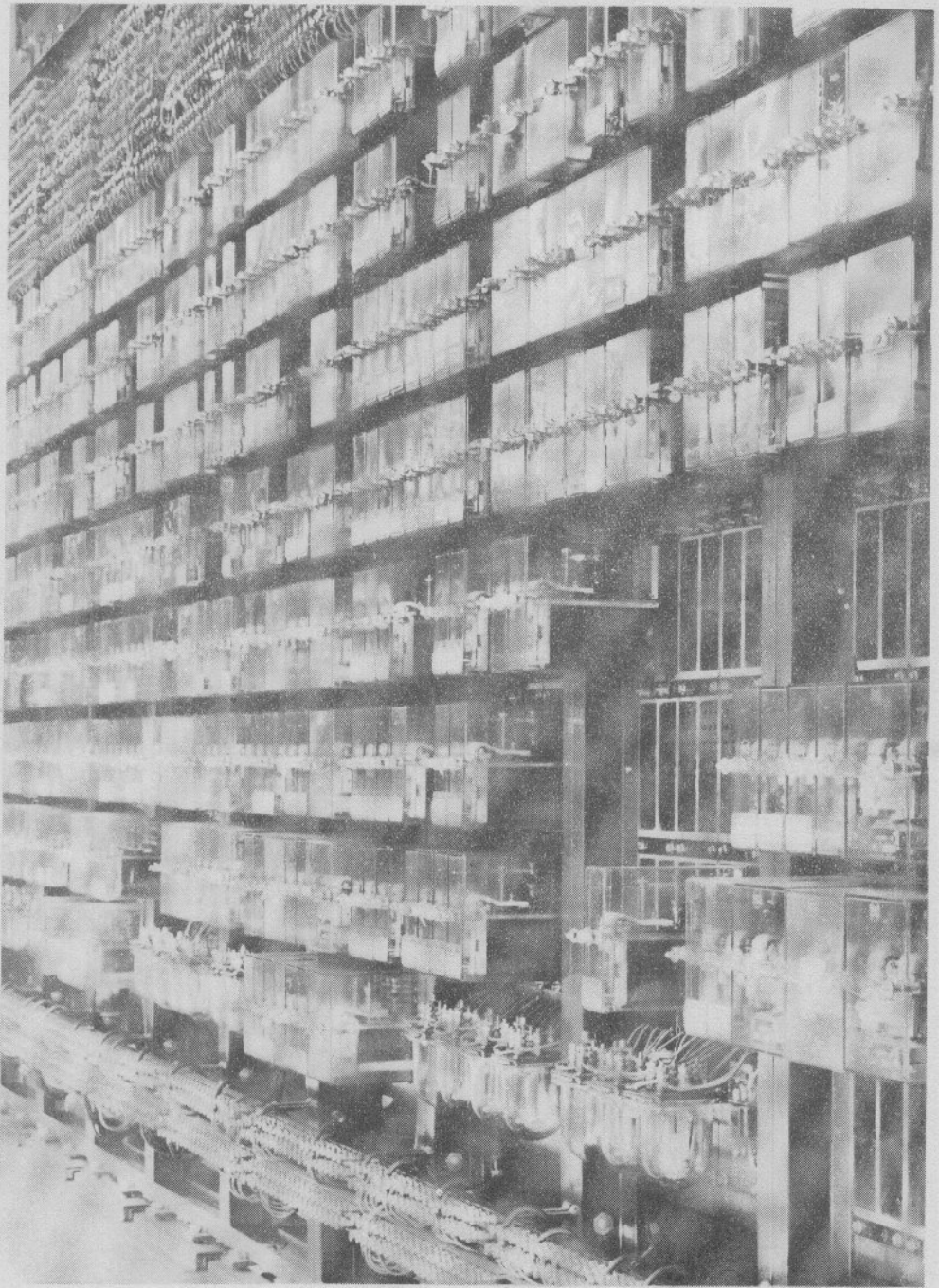

Figure 2. Type B relays on rack installed in tower

### I. GENERAL DESCRIPTION OF TYPE B RELAYS

The need for a small quick-detachable relay with a relatively large contact combination capacity was the purpose behind the design of the Type B relay. It is made in two standard sizes, the overall dimensions being as follows:

Size 1 - Height 6-5/16"	Size 2 - Height 6-5/16"
Depth 8-9/16"	Depth 8-9/16"
Width 2-7/16"	Width 4-15/16"

Two Size 1 relays take the space required by one Size 2 relay. The relays are "plugged" on to plugboards of molded bakelite, so designed that both halves of the plugboard, on either side of the vertical center-line, are the same.

The plugboards, on which relays are plugged, are bolted

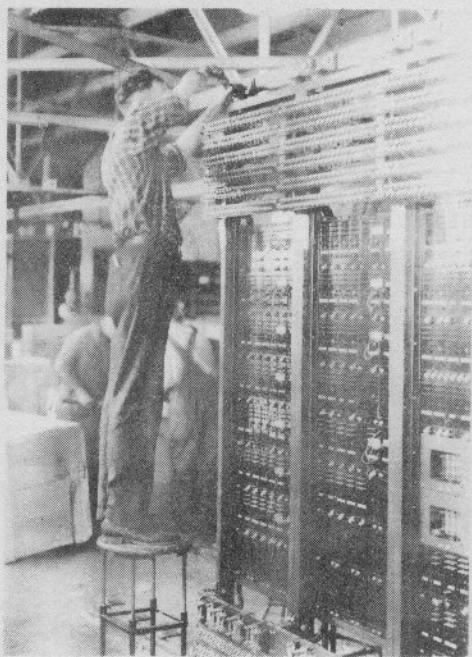

Figure 3. Dismantling tower relay rack

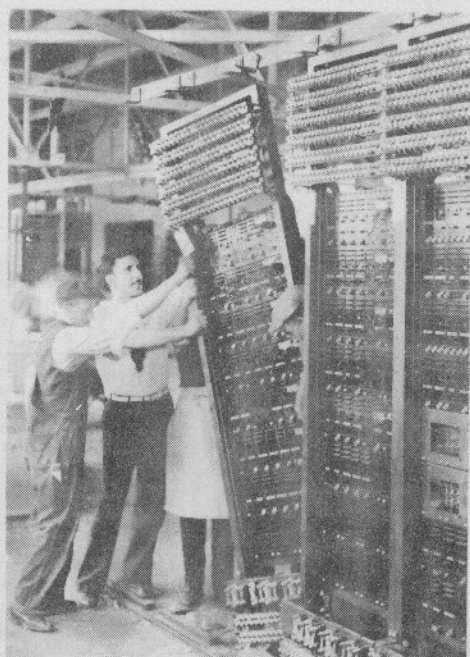

Figure 4. Removing a section of the rack



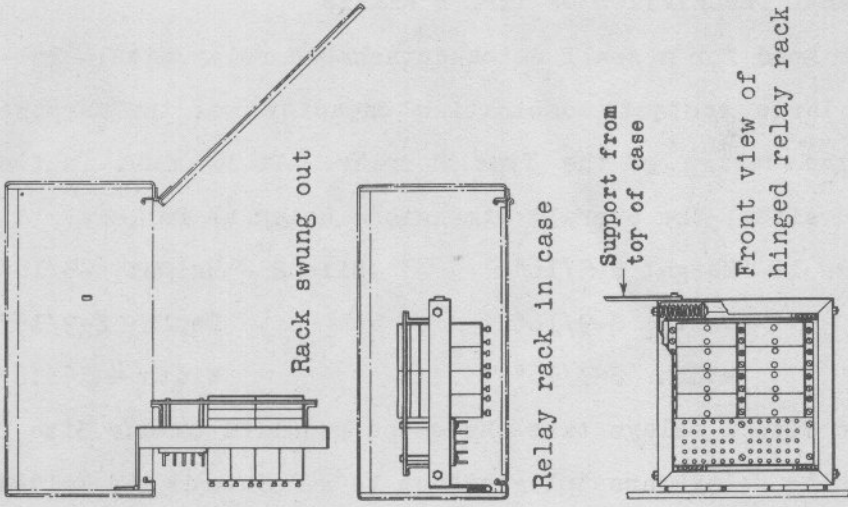

Figure 6. Hinged relay rack for instrument cases

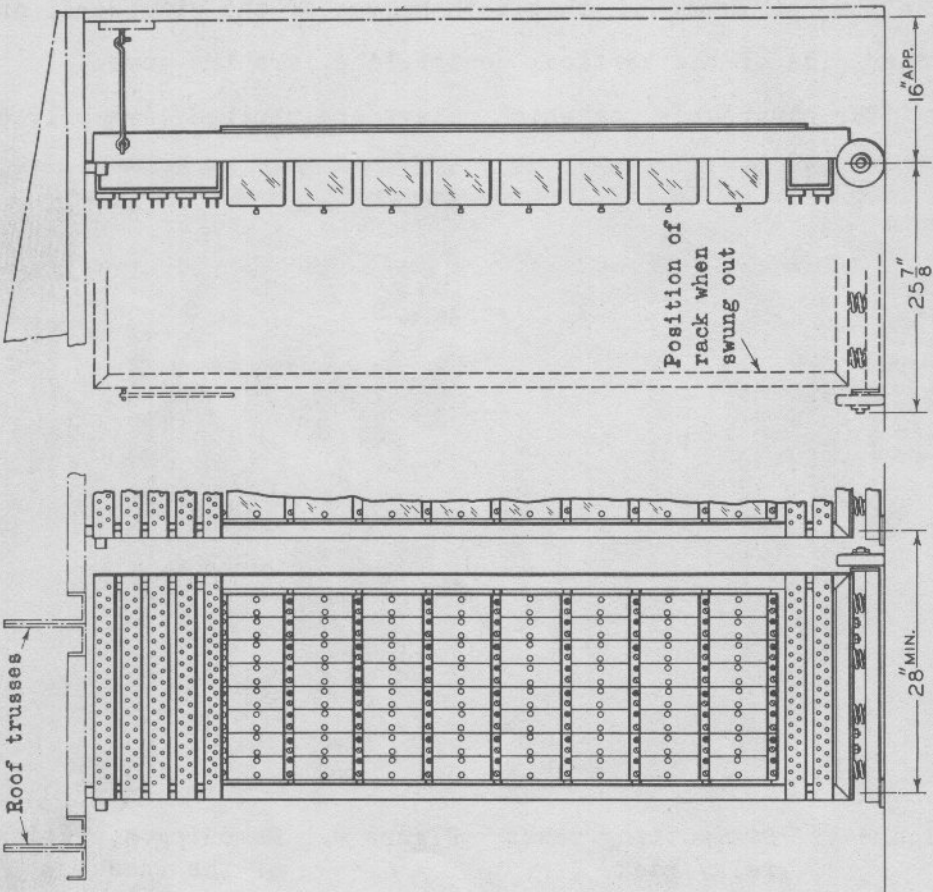

Figure 5. Hinged relay rack for towers and housings

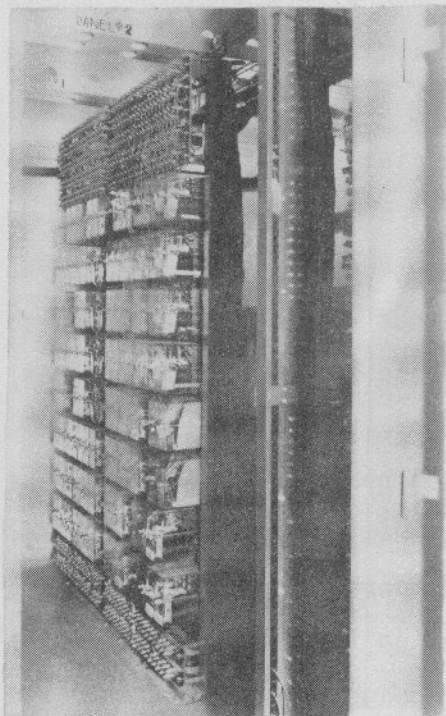

Figure 7. Type B relays  
in instrument housing

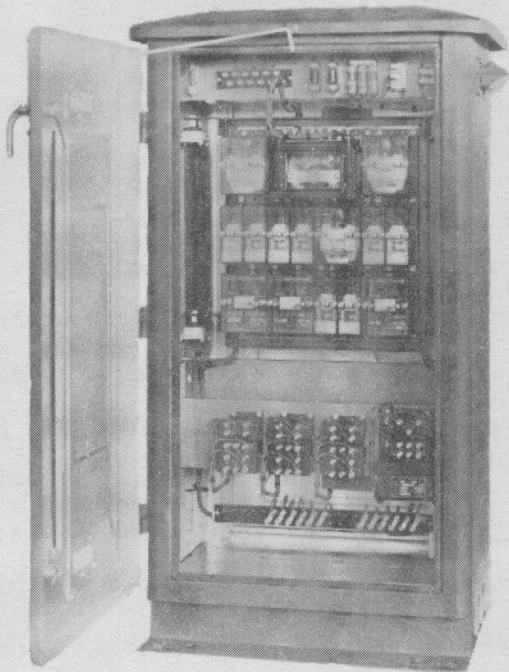

Figure 8. Type B relays  
in high relay case

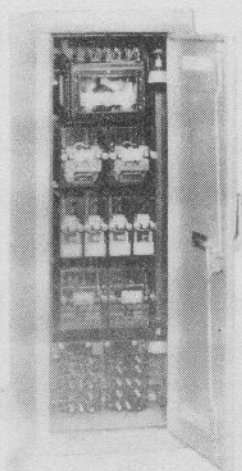

Figure 9. Type B relays  
in special narrow case

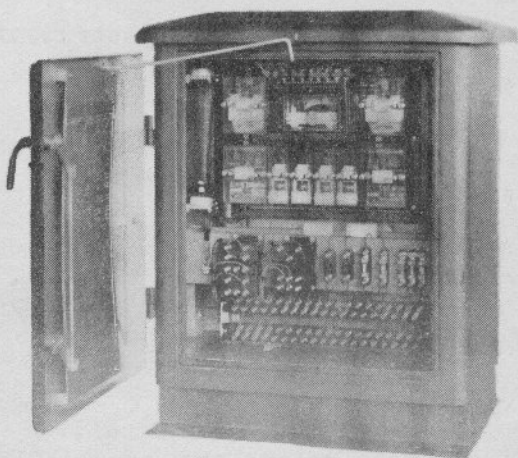

Figure 10. Type B relays  
in low relay case

to 1/4" by 3/4" steel bars supported on a rack section, generally 2 feet wide and of a varying height. The rack is cushioned top and bottom, when required, and the bearing plates are bolted to the floor and to a suitable ceiling support.

All racks are completely wired and tested in the factory prior to shipment. Tower racks are then stripped of relays, relay guide rods, and any jumpers that connect one section to another, and are shipped as complete units with plugboards, wiring, and terminal boards in place. See Figures 3 and 4.

Upon arrival, the top and bottom bearing plates are bolted in place in the tower. The racks are next bolted to the plates, the guide rods assembled on the plugboards, and relays plugged in. This procedure cuts construction time considerably.

An alternate method of installing racks is illustrated in Figures 5 and 6. Figure 5 shows a hinged rack which can be installed in a tower against a wall and swung out when access is to be gained to the wiring. Figure 6 illustrates a hinged mounting for instrument cases such as are shown in Figures 8 and 10.

Racks in instrument housings, Figure 7, are permanently installed and wired in place. They are cushioned the same as tower racks, and are the same width.

Type B relays in instrument cases are shown in Figures 8 and 10. The same cushioned construction is used to absorb vibration.

These relays are especially adaptable in narrow places where space is an important factor. A special narrow case (with relays) for close clearances is shown in Figure 9.

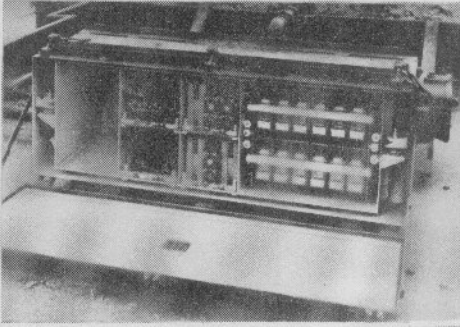

Figure 11. Type B relays in G-R-S cab signal mechanism case on a steam road.

Cab signaling and speed control systems installed on electric and steam roads are now using Type B relays in the car equipments, Figures 11 and 12.

The Type B's compactness, its quick-detachable plug-in feature, its ability to withstand severe vibration, and its large contact combination capacity readily adapt it to train control service.

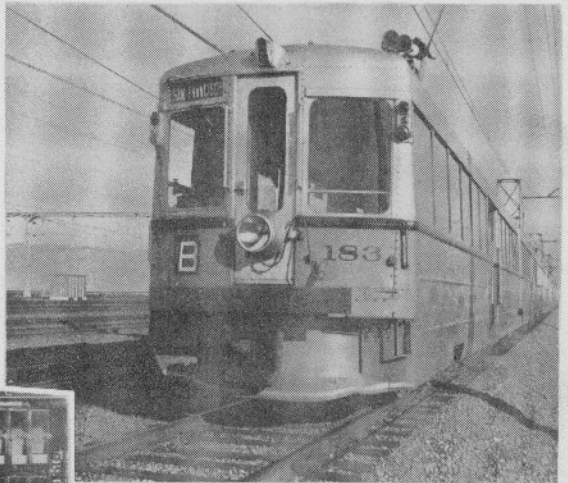
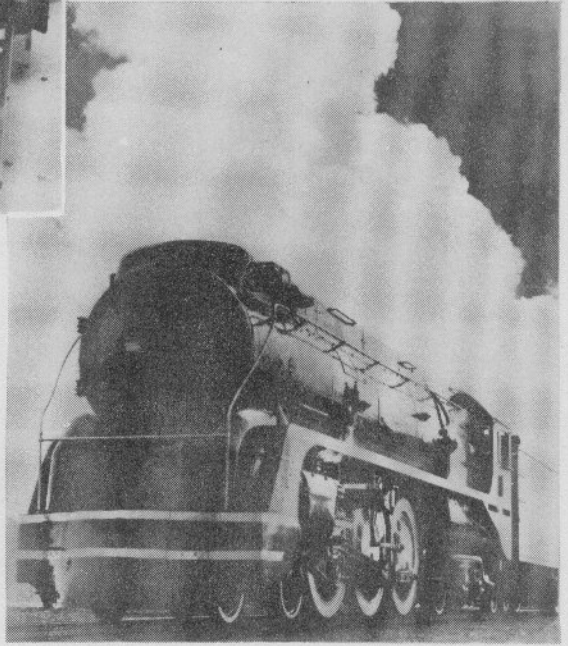
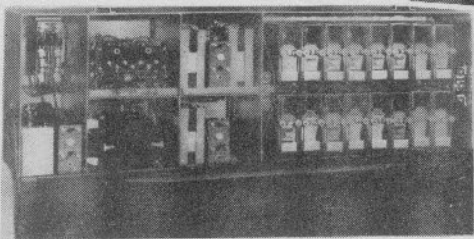

Figure 12. Type B relays on electric cars equipped with G-R-S cab signaling and speed control.



The Type B line of relays consists of the following:

- (a) Size 1 d-c. neutral relay, Figure 13, and Catalog Section E Part 31.
- (b) Size 2 d-c. neutral relay, Figure 14, and Catalog Section E Part 31.
- (c) Size 2 d-c. neutral polar relay, Figure 16, and Catalog Section E Part 32.
- (d) Size 2 d-c. retained-neutral polar relay, Figure 18, and Catalog Section E Part 32.
- (e) Size 2 a-c. vane relay, two- and three-position, Figures 23 and 24, and Catalog Section E Part 33.
- (f) Size 1 a-c. or d-c. thermal relay, Class TG and TJ, Figures 30 and 33, and Catalog Section E Part 34.

## II. THE DIRECT-CURRENT RELAYS

### A. General Characteristics

All the d-c. relays have molded bakelite bases. The cores are bolted through the base, and the coils, which are wound on bakelite spools, are slipped over the cores. Prongs, which are part of the quick-detachable feature (described on page 41), protrude from the coil assembly through the base of the relay.

The two coils of the Size 1 neutral relay are placed one above the other. Those of the Size 2 relays are arranged side by side. The winding combinations to give special time or circuit requirements are discussed under "D-c. Relay Winding Combinations", page 27, and are illustrated in Figures 20 and 21.

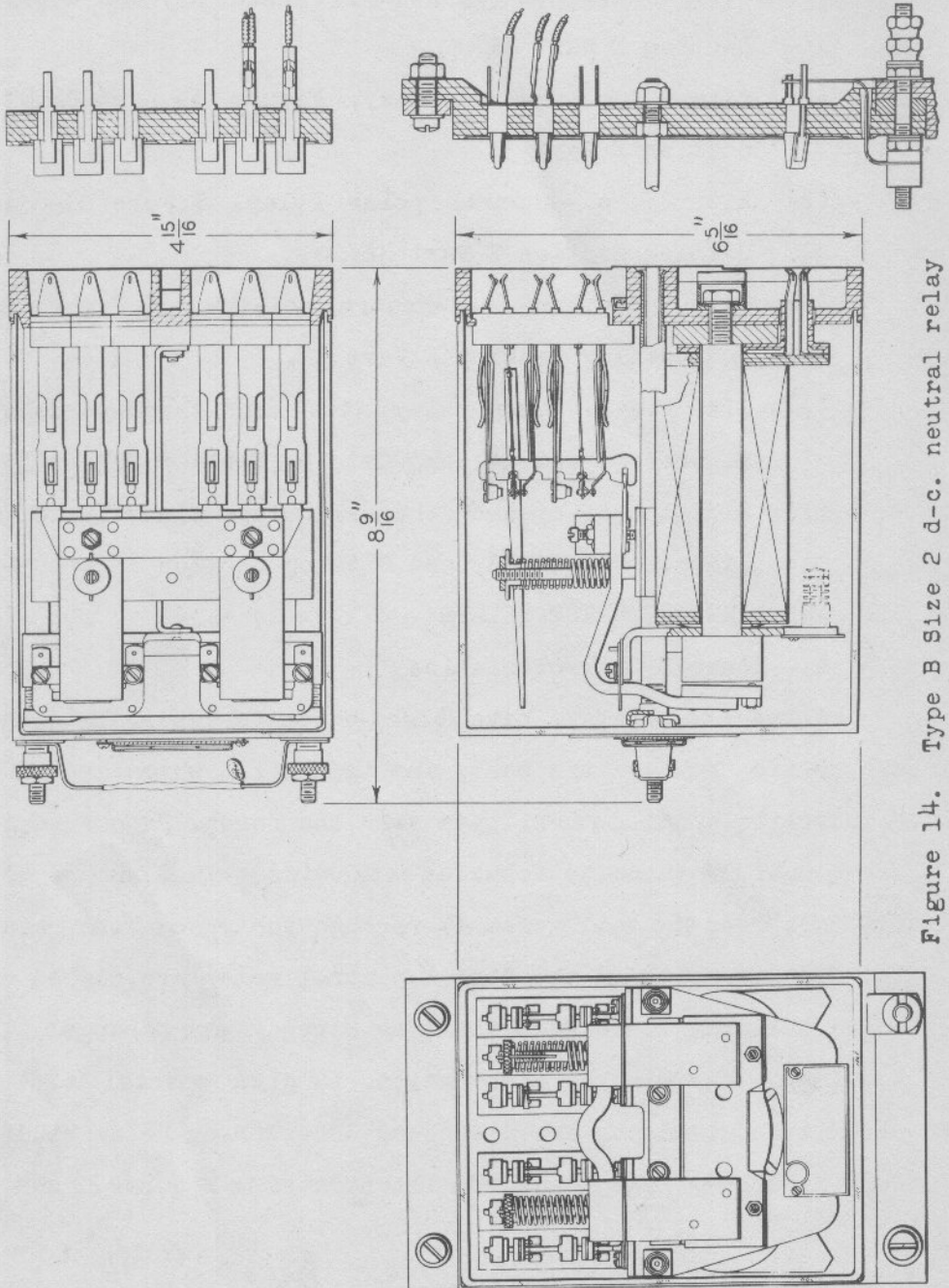

Figure 14. Type B Size 2 d-c. neutral relay

An L-shaped armature, pivoted on a rocker bearing, actuates the neutral contact springs through insulating pushers. Long coil springs, the compressive force of which remains practically constant throughout the travel of the armature, provide additional back contact pressure. The contacts are molded in bakelite in specified arrangements described under "Contact Combination Capacity of D-c. Relays", page 23.

The Size 1 neutral relay is furnished with a maximum capacity of six dependent front-back contacts. Where greater contact capacity than that afforded by the Size 1 relay is required, the Size 2 neutral relay is available. This relay has double the contact combination capacity of the Size 1, as explained on page 23.

The neutral polar and retained-neutral polar relays are furnished in the Size 2 only.

The transparent covers are made of molded plastic which is very tough and difficult to break.

Since the theory of operation of d-c. neutral relays is well known and understood, it is thought unnecessary to describe it. The theory of operation of the neutral polar and retained-neutral polar relays, however, is perhaps not so familiar; hence an explanation is briefly given in the next section.

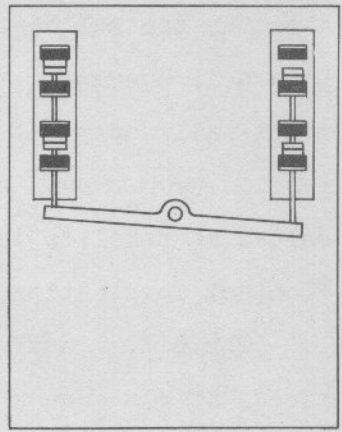
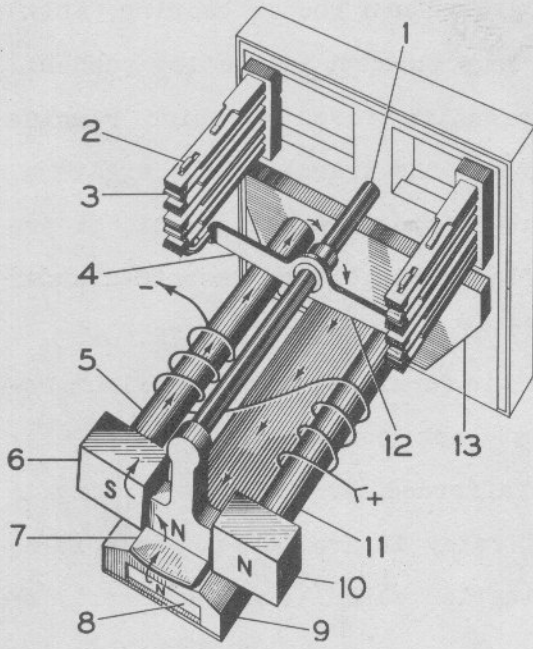

(a) Normal position

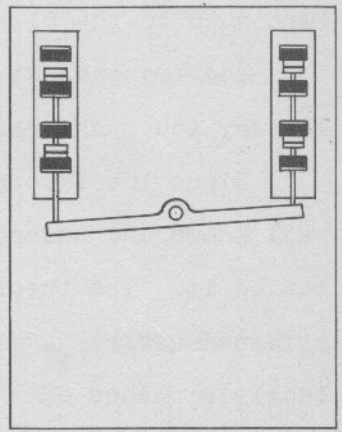
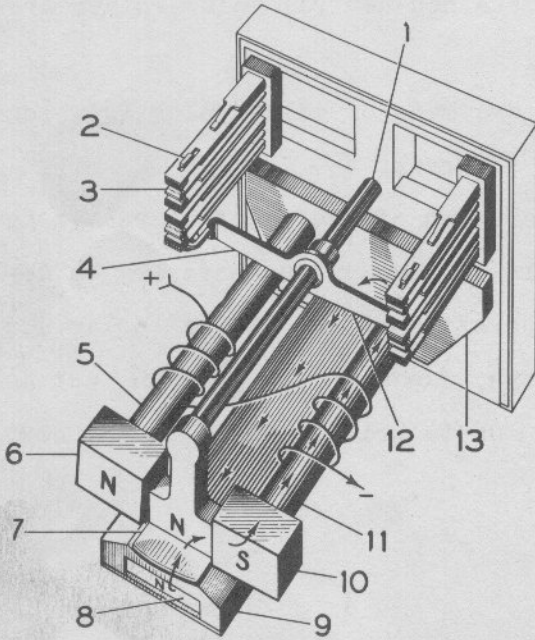

(b) Reverse position

Figure 15. Polar magnetic structure of Type B neutral polar relays; polar armature and contacts shown in normal and reverse positions.



## B. Theory of Operation of Neutral Polar Relays

Figure 15 shows the magnetic structure of a Type B neutral polar relay. The neutral armature is removed to show the details of the polar structure.

The axis 1 of the polar armature 7 of both neutral polar and retained-neutral polar relays runs from front to back of the relay. Reversal of current flowing through the two coils, which are slipped over cores 5 and 11, causes the polar armature to rock from normal to reverse and vice versa.

The normal position, looking at the front of the relay, is shown in Figure 15(a) on the opposite page. Arms 4 and 12, extending from the armature, actuate the polar contact springs 3 through insulating pushers 2.

Because of the efficiency of the polar magnetic structure, the armature remains strongly attracted to its last operated position with all energy cut off the relay coils. It is possible to operate a maximum of eight polar normal-reverse dependent contacts.

Under the polar armature and separated from it by an air-gap is a permanent magnet 8, which is attached to yoke 13. This yoke forms a common path for magnetic flux from cores 5, 11, and permanent magnet 8.

When the relay is polarized normal, current flows through the coils in the direction shown, producing polarity in cores 5 and 11 as marked, N meaning North, S South.

The polar armature 7, because of its proximity to pole piece 9 attached to the North end of the permanent magnet,

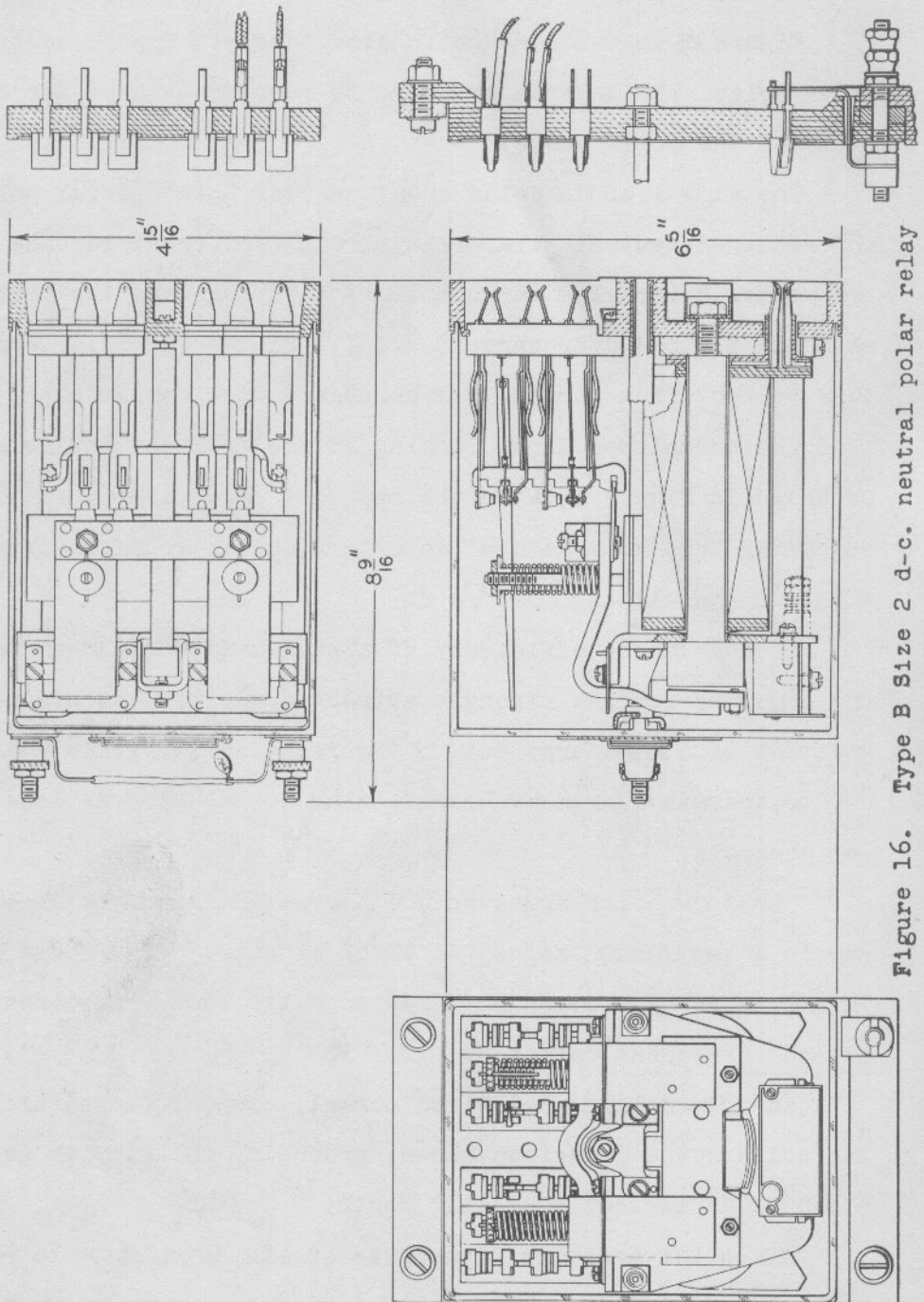

Figure 16. Type B Size 2 d-c. neutral polar relay

takes on North polarity. It is repelled by pole piece 10 (like poles repelling) and is attracted by pole piece 6 (unlike poles attracting). The path of the flux is shown by the arrows.

Should the relay now be polarized reverse, current would flow through the windings in the opposite direction, as shown in Figure 15(b). Polarities of cores 5 and 11 are now reversed. Polar armature 7, retaining its North polarity, is repelled by pole piece 6 and attracted by pole piece 10.

The sequence of events that occur when a Type B relay is pole-changed, is as follows, assuming the relay is energized in the normal position:-

1. When the current is cut off the windings momentarily, the flux collapses in cores 5 and 11 and the neutral armature (not shown) drops away from pole faces 6 and 10.
2. While the current is applied in the opposite direction through the windings, the flux in cores 5 and 11 gradually builds up in the reverse direction, as shown in Figure 15(b).
3. When the current builds up to the polar pickup value, the polar armature reverses.
4. As current builds up to the pickup value, the neutral armature is again picked up.

With the wide spread between the current value required to operate the polar armature and that required to pick up the neutral armature, the polar contacts snap over first. The relayed circuits are then closed by the neutral contacts.

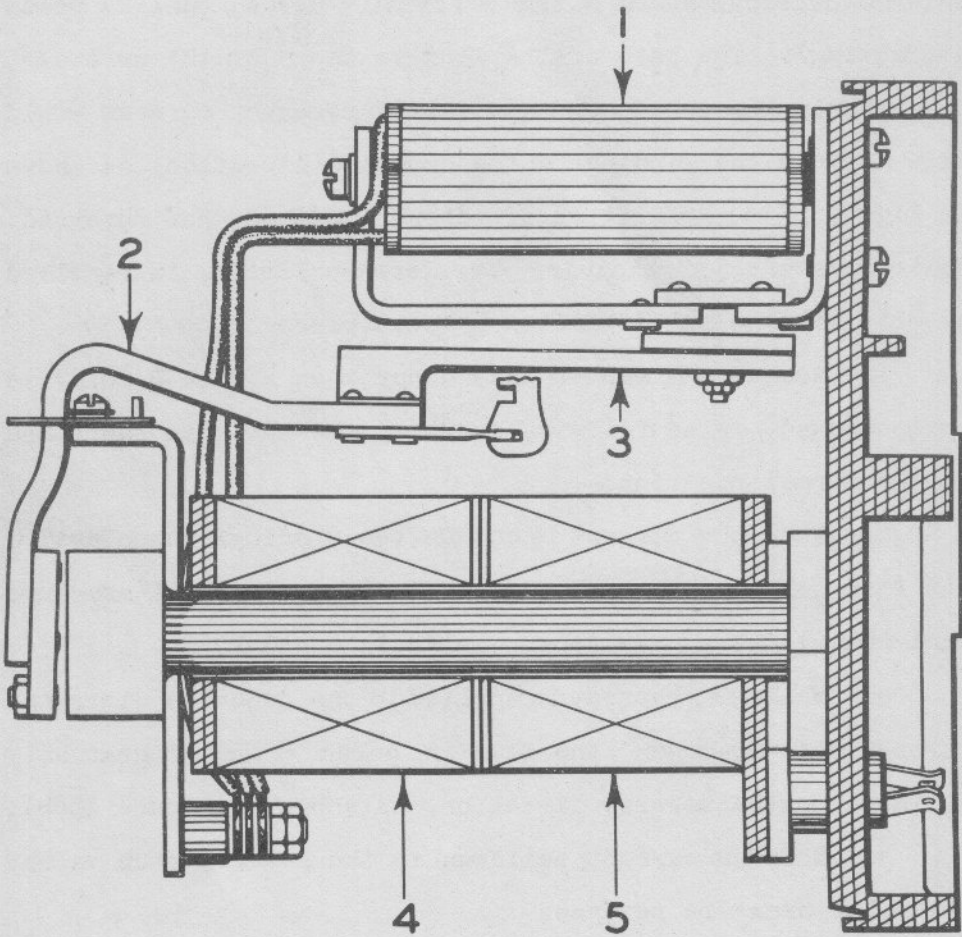

Figure 17. Neutral retaining structure of Type B retained neutral polar relays.

### C. Theory of Operation of Retained-Neutral Polar Relays

It is a characteristic of neutral polar relays that the neutral armature momentarily drops away when the relay is pole-changed, as was described on page 19.

It is sometimes desirable to hold the neutral armature up during pole-changing. This is done, Figure 17, by placing a secondary winding 4 on the main magnetic structure of the relay. The secondary winding is connected in series with a "retaining coil" 1, which is mounted among the contacts and takes the space occupied by one contact block. When current flows in the retaining coil 1, an extension 3 on the neutral armature 2 is attracted upwards, thus "retaining" the neutral armature in the energized position. Hence, the name "retained-neutral" polar relay.

The energization of the retaining coil 1 is caused by the voltage induced in the secondary winding 4 which is placed, as stated before, on the main magnetic structure of the relay. When the current in the relay's operating windings 5 is pole-changed, thus decreasing rapidly to zero and building up to full strength once more (in the opposite direction), the resulting decrease and increase of the magnetic lines of force induce a voltage in the secondary winding. This action is familiarly known as "transformer action". The induced voltage causes current to flow in the retaining coil during the pole-changing period only, thus retaining the neutral armature.

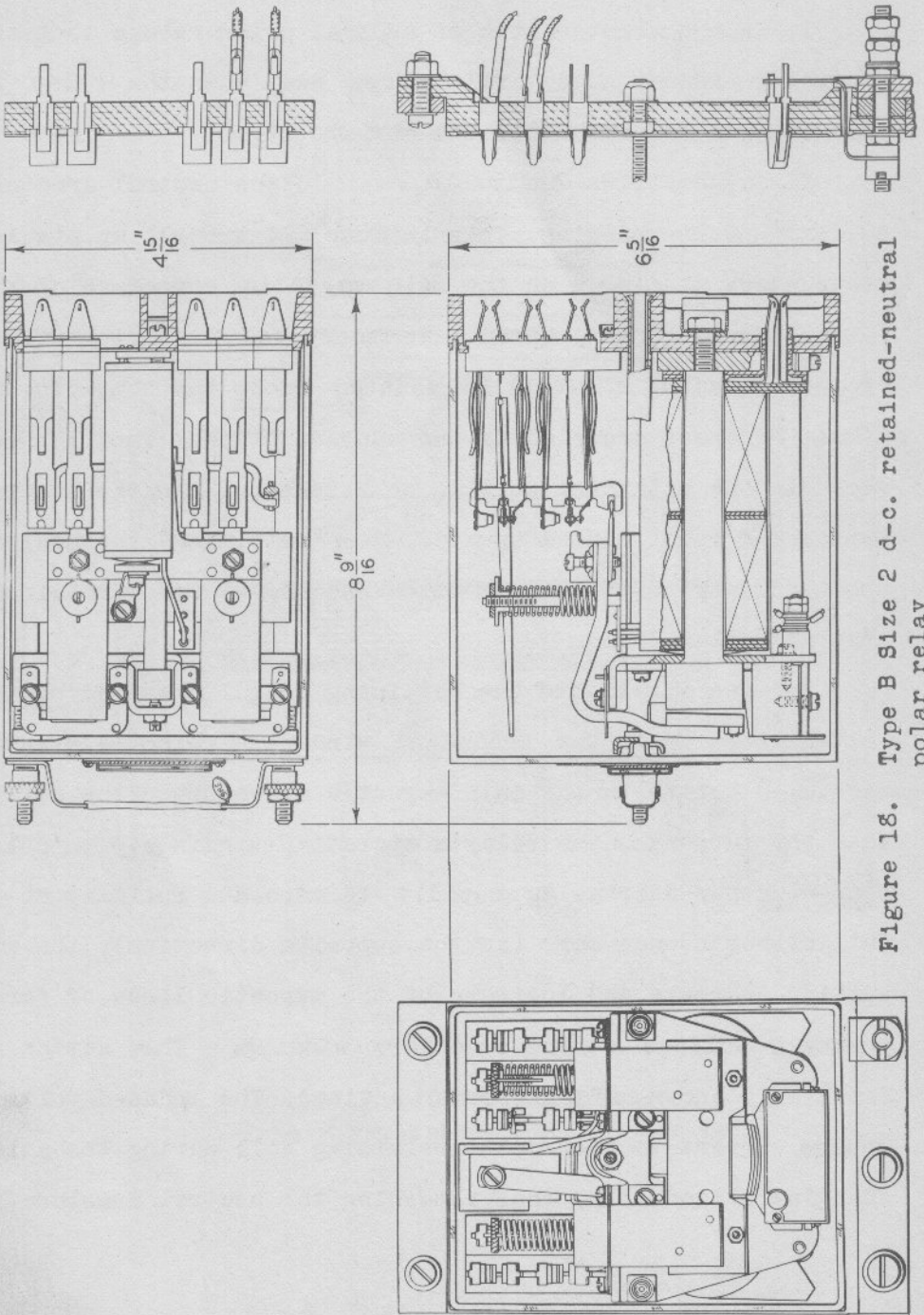

Figure 18. Type B Size 2 d-c. retained-neutral polar relay

#### D. Contact Combination Capacity of D-c. Relays

The contact springs are molded in bakelite, a maximum of six springs per block. The Size 1 relay accomodates three blocks or a maximum of 18 springs; the Size 2 relay six\* blocks, or a maximum of 36 springs.

Reference henceforth is made to "dependent" and "independent" contacts. A dependent contact is a group of three contact springs designed to complete one of two circuits. An independent contact is a group of two contact springs designed to complete one circuit only.

The blocks of contact springs are molded in the representative combinations shown in Figure 19. Spring stops are also molded in the bakelite alongside all front and back contact springs. See Catalog Section E Part 31 Plate E3141 for ordering references.

Representative contact combinations for the d-c. relays are given in Tables I, II, III, and IV, page 25.

Standard front contacts supplied with Type B relays are silver to silver-impregnated carbon; back contacts are silver to silver; polar contacts are silver to silver-impregnated carbon. Front contacts can also be supplied silver to silver and back contacts silver to silver-impregnated carbon.

Heavy-duty contacts of silver or tungsten are available; also extra-heavy-duty contacts equipped with magnetic blowouts.

Front contact openings are 0.050", 0.090", and 0.125" as specified.

\* The retained-neutral polar relay is the exception. It has room for five blocks, the retaining coil taking the space of one block, see page 21.

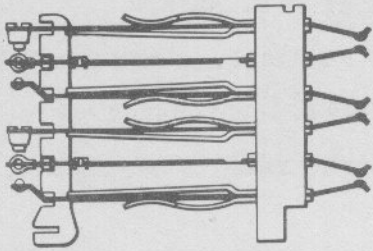

Two dependent front-backs

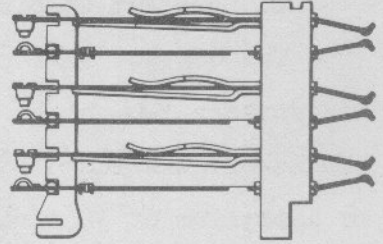

Three independent fronts

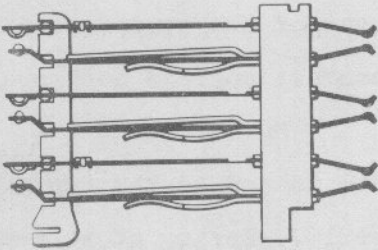

Three independent backs

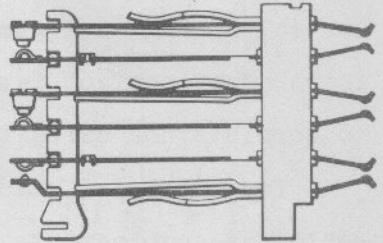

Two independent fronts and one independent back

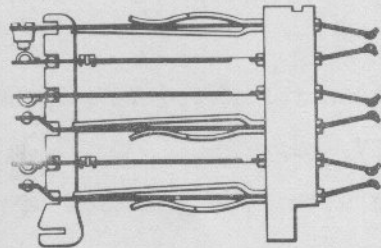

One independent front and two independent backs

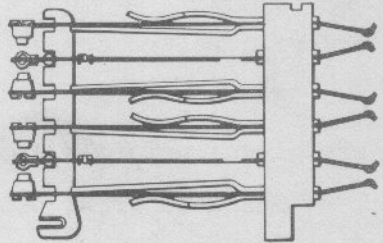

Two dependent normal-reverse polars

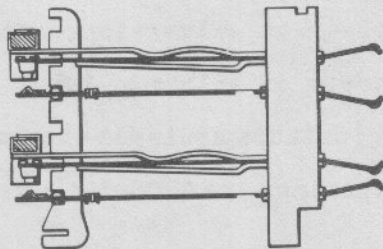

Two independent fronts with magnetic blowouts for heavy duty

Figure 19. Representative contact combinations for d-c. relays

(See Catalog Plate E3141 for other combinations)



In the following tables,

FB means dependent front-back contacts

F means independent front contacts

B means independent back contacts

MB means dependent front-back contacts with the "make-before-break" feature

NR means dependent normal-reverse polar contacts

TABLE I

Representative Contact Combinations of Type B Size 1 D-c. Neutral Relays

FB	F	B	MB
2			
4			
6			
	3		
	9		
4	3		
2	1	2	
2	1	5	
2	2	4	
2	4	2	
4	2	1	
	4	2	
	4	5	
	5	4	
	6	3	
	7	2	
	8	1	
1	2	4	1
3		3	1

TABLE III

Representative Contact Combinations of Type B Size 2 D-c. Neutral Polar Relays

FB	F	B	NR
4			4
4			8
6			4
8			4
4	3		4
4	6		4
4	4	2	4
2	3		4
2	1	2	4
2	4	5	4
2	3	3	4
	3	3	4
	5	1	4

TABLE II

Representative Contact Combinations of Type B Size 2 D-c. Neutral Relays

FB	F	B
12		
8	6	
6	9	
6	7	2
4	8	4
4	4	8
	8	7

TABLE IV

Representative Contact Combinations of Type B Size 2 D-c. Retained-Neutral Polar Relays

FB	F	B	NR
4			4
2	2	1	4

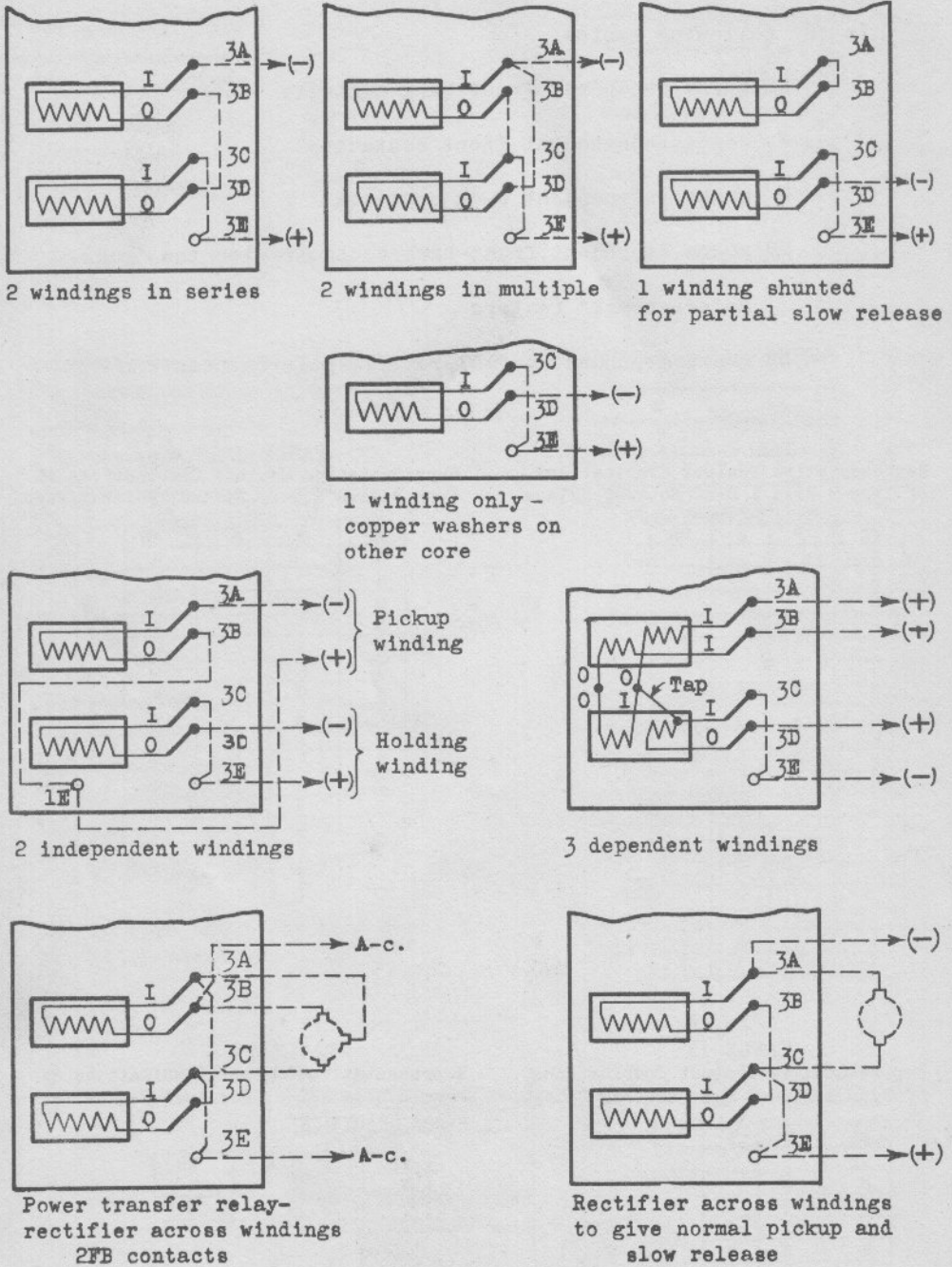

Figure 20. Type B Size 1 d-c. relay winding combinations

### E. D-c. Relay Winding Combinations

In describing winding combinations it is necessary first of all to clarify certain terms.

All Type B d-c. relays have space enough on a core for one full length coil, approximately four inches long. Coils shorter than this are used when the cores are partly filled with copper washers.

A coil may be made up of one or two separate windings, leads from these windings being terminated at the prongs in the relay base, or connected within the relay, as in the case of the retained-neutral polar relay.

With various combinations of short-circuited windings, rectifier and resistor shunts, copper washers and magnetic shunts, a number of different relay characteristics may be obtained. The following are representative:

1. Normal pickup and release.
2. Quick pickup and slow release.
3. Slow pickup and partial slow release.
4. Slow pickup and slow release.

Figures 20 and 21 show representative winding combinations of Type B d-c. relays. Coils are represented by the heavy rectangles; the windings by the zig-zag lines. The "in" lead of the winding is indicated by letter "I", the "out" lead by "O".

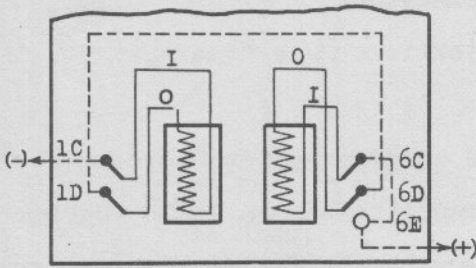

Neutral and neutral polar relays  
2 windings in series

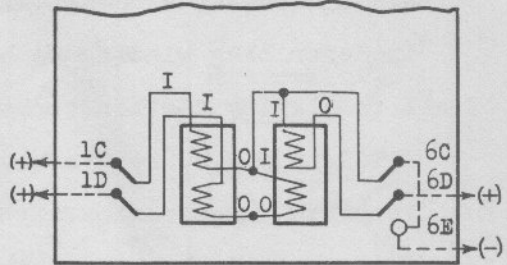

Neutral relay  
3 dependent windings

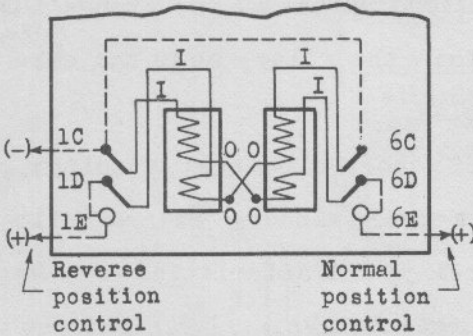

Reverse position control      Normal position control

Neutral polar relay  
1 Normal position winding  
1 Reverse position winding

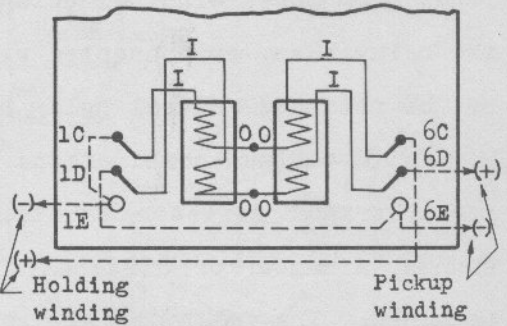

Holding winding      Pickup winding

Neutral polar relay  
1 Quick pickup winding  
1 Holding winding

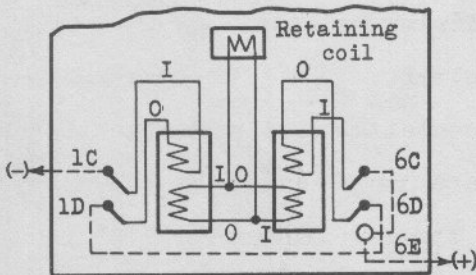

Retaining coil

Retained-neutral polar relay  
2 windings in series

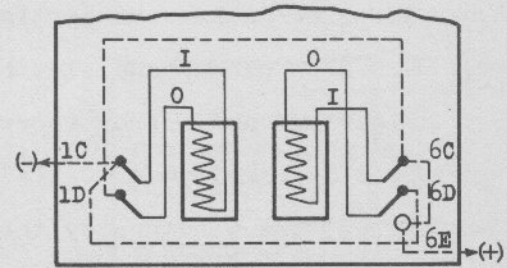

Neutral and neutral polar relays  
2 windings in multiple

Polar contacts on polar relays assume normal position (lower right-hand and upper left-hand contacts made) when windings are energized with polarity as shown

Figure 21. Type B Size 2 d-c. relay winding combinations

The relay prongs and plugboard terminals are shown as sloping heavy lines. The dot on the sloping line represents the soldered connection between the plugboard terminal and the external wiring. The internal wiring of the relays is shown by solid lines; the external plugboard wiring by broken lines.

The terminal numbering is explained in Section IX, "Relay Nomenclature", page 49.

#### F. Test Terminals

All Type B d-c. relays are provided with test terminals; see Catalog Plate E3135. These are mounted on the plugboards and directly underneath their respective relays. One terminal is associated with each relay. Two terminals may be used if relay has two independent windings. The leads from the various windings are connected to the test terminals in such a way that by backing off the terminal nut, Figure 22, the relay can be made to release. By using a special tool, Figure 48, which attaches to the terminal (described later), a milliammeter may be easily inserted in the circuit for taking relay operating values. These terminals are numbered "1E", "3E", and "6E" in Figures 20 and 21.

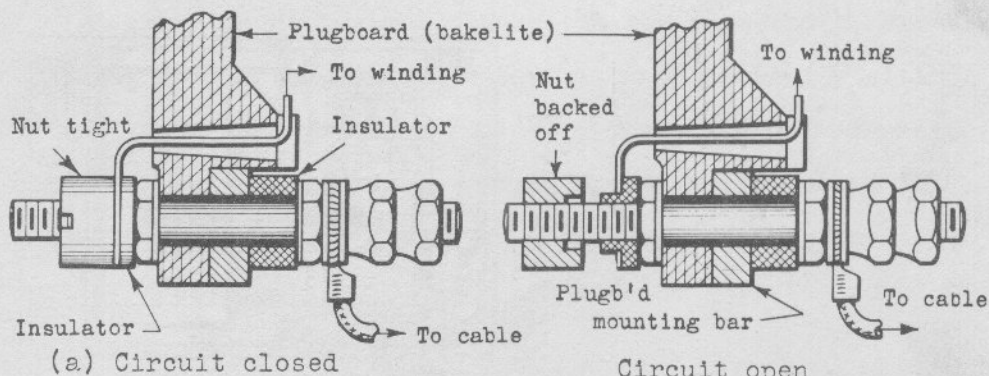

Figure 22. Test terminal for opening winding

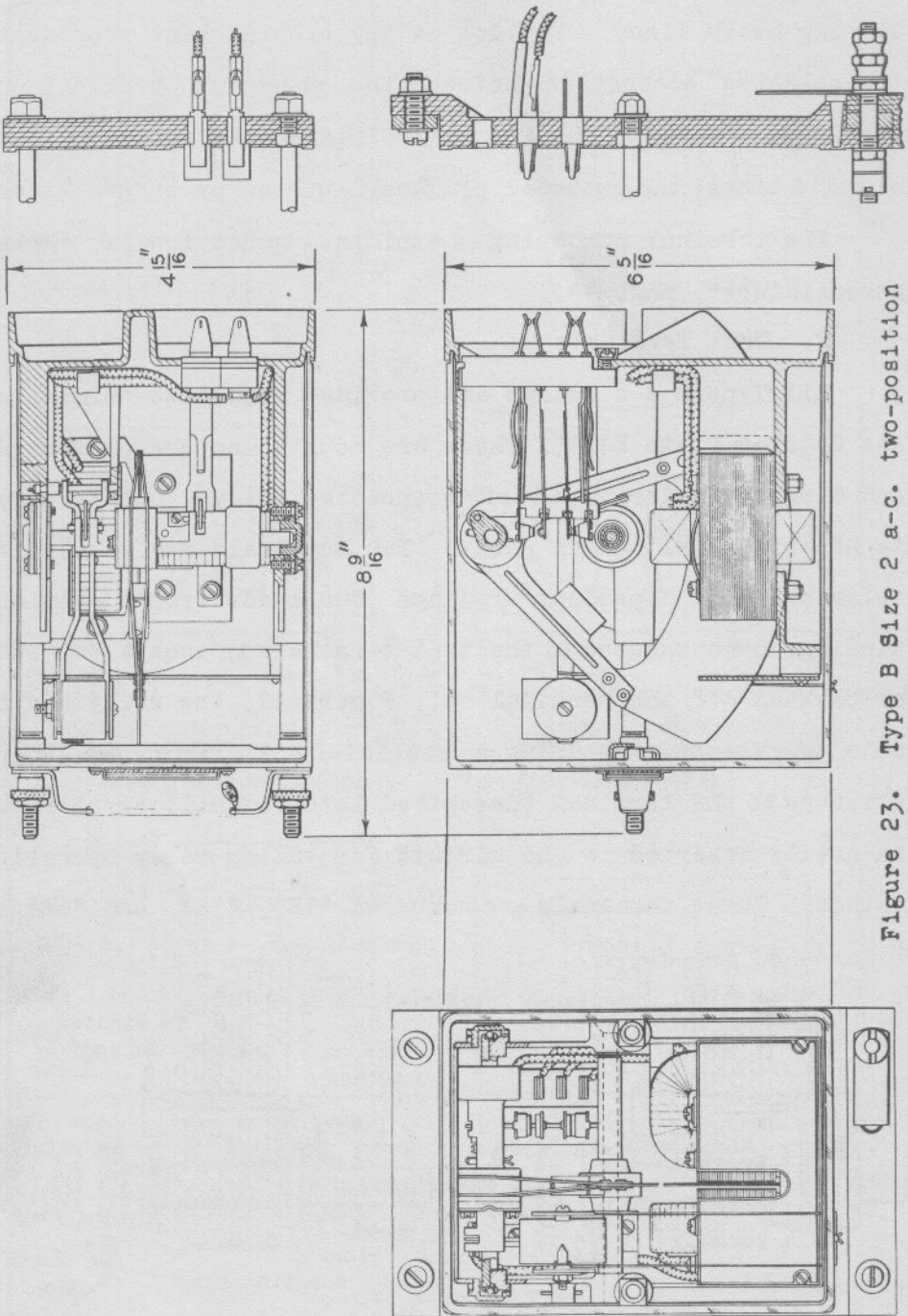

Figure 23. Type B Size 2 a-c. two-position vane relay

### III. THE ALTERNATING-CURRENT RELAYS

#### A. General Characteristics

Type B a-c. relays use the Size 2 structure only, and are plugged on to the standard plugboard used with the d-c. relays.

The line of a-c. relays consists of the following:

- (a) Two-position relay for line or track on any commercial frequency; two elements, local voltage 55 or 110, line voltage as specified, Figure 23, and Catalog Plate E3301.
- (b) Three-position relay for line or track on any commercial frequency; two elements, local voltage 55 or 110, line voltage as specified, Figure 24, and Catalog Plate E3351.

The base and framework of the relay are made of die-cast aluminum. The vane is clamped to a shaft supported at the ends on knife-edge bearings screwed to the relay framework. The vane is free to move in an air-gap between the magnetic structure of the local element and the line or track element. When the relay is energized the vane rotates, pulling upwards on an insulating link connected to the contacts.

A heavy counterweight, linked to the vane shaft, exerts a strong pull on the vane to restore it to the normal position. This gives a high dropaway value. The efficient magnetic structure permits of low operating energy. The combination produces a relay which has a high dropaway-working percentage. Contact pressure, resistance, and current carrying capacity meet A. A. R. requirements.

A molded transparent plastic cover protects the working parts of the relay.

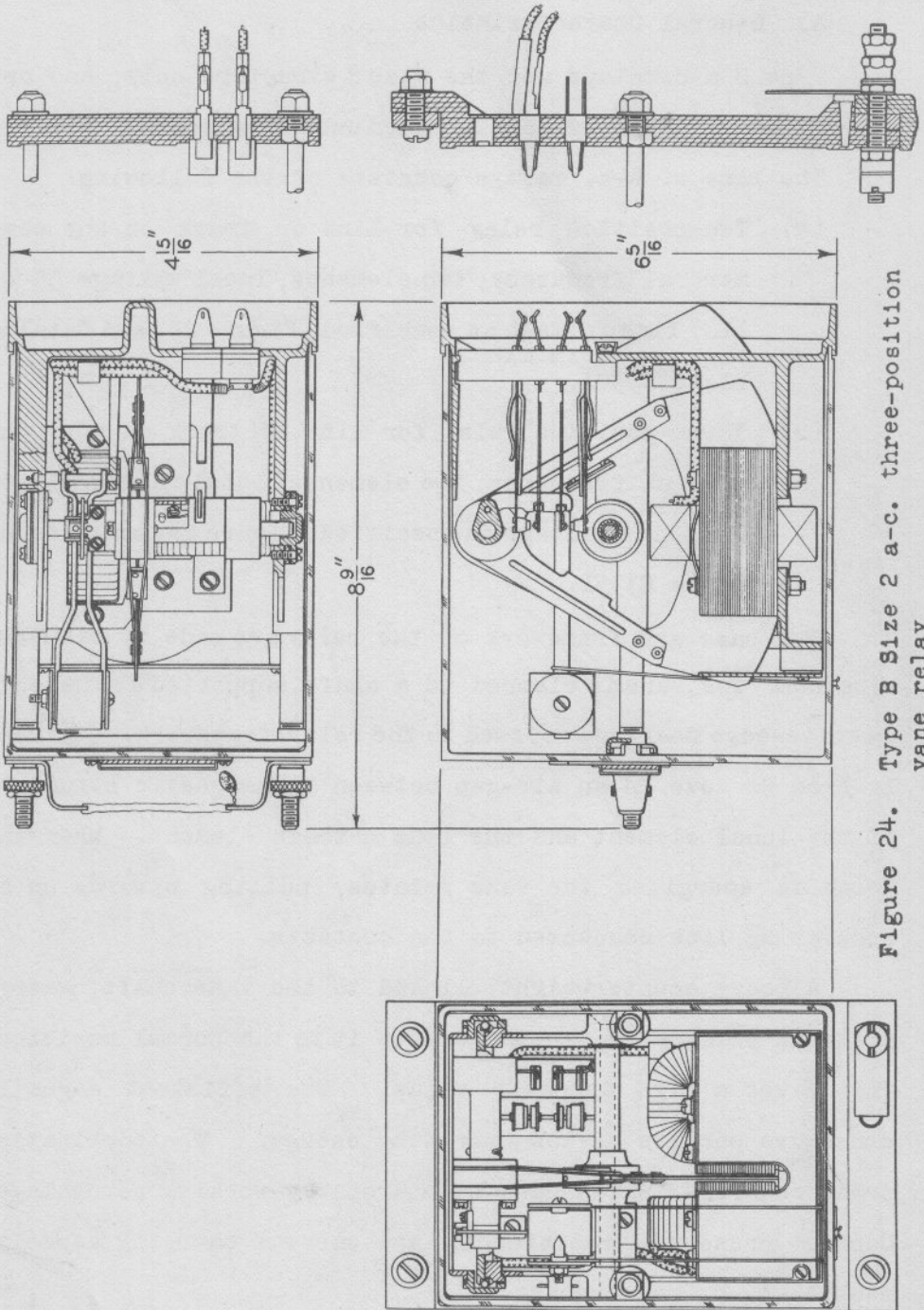

Figure 24. Type B Size 2 a-c. three-position vane relay



## B. Contact Combination Capacity of A-c. Relays

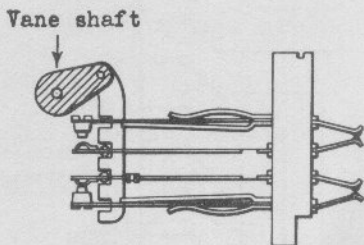

Figure 25. Contacts on two-position a-c. vane relay

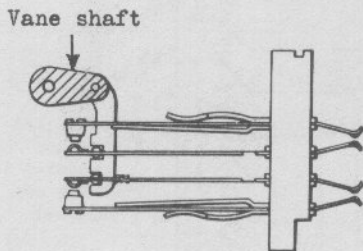

Figure 26. Contacts on three-position a-c. vane relay

The two-position relay is equipped with one independent front and one independent back contact; both are silver to silver-impregnated carbon, Figure 25. The three-position relay has one independent normal and one independent reverse contact; both

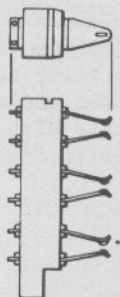

Figure 27. Coil terminal block for a-c. vane relays

are silver to silver-impregnated carbon, Figure 26. Ordering references given in Catalog Section E Part 31 Plate E 3141.

As in the d-c. relays, the contacts are molded in bakelite, the block held in place by one screw on the relay framework. A similar block, Figure 27, with prongs molded into it, forms the terminals to which the coil leads are soldered.

Built with this light contact structure, the Type B vane relay is commonly used with a d-c. neutral repeater relay through which the signal system circuits are broken.

The combination of the track relay and repeater gives a shunting sensitivity greatly in excess of that obtained with any former a-c. relay under equivalent service conditions, plus the advantages of the slow-pickup characteristic of the repeater relay.

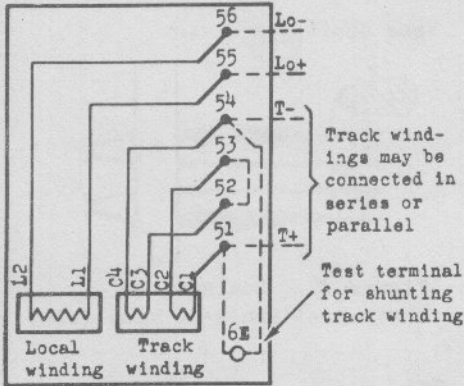

(a) Two-position relay used as a track relay on short single-rail and condenser-fed track circuits with track windings in series

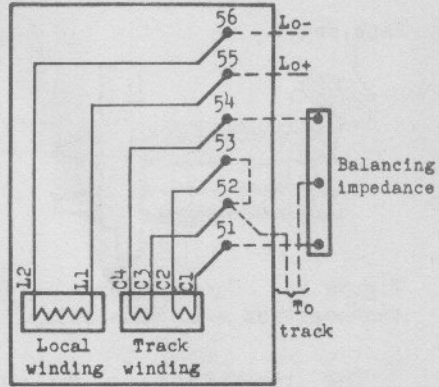

(b) Two-position relay used as a track relay on longer single-rail track circuits where current caused by propulsion voltage drop must be balanced in track windings

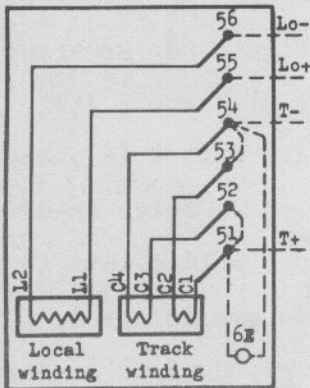

(c) Two-position relay used as a track relay on double-rail track circuits with track windings in parallel; steam or electric road

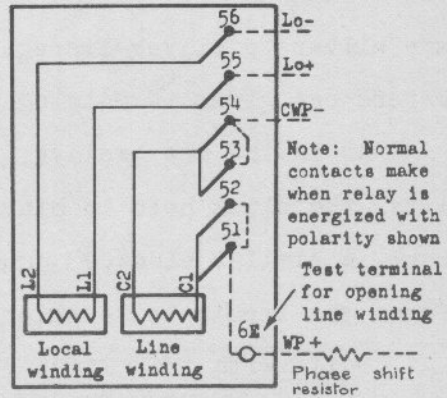

(d) Three-position relay used as line relay. Same winding connections apply to a two-position relay

Figure 28. Winding connections of Type B a-c. vane relays

### C. A-c. Relay Winding Combinations

The windings are mounted on laminated structures on the base of the relay. Viewed from the front of the relay, the local winding is to the left of the vane, the line or track winding is to the right.

In Figure 28 diagrams of winding connections are shown for two- and three- position relays.

For the usual track application, where the relay is connected directly to the track leads, one type of relay can be used regardless of length or type of track circuit. When the relay is to be housed in a central tower, as at interlockings, where the resistance of the leads from relay to track exceeds 0.5 ohm, the same relay with a high impedance track winding is available for use with a booster transformer. With one standard relay for the usual applications, track circuit adjustments are simplified to the extent that only one relay calibration need be taken into consideration.

Silver-plated plugboard terminals and relay prongs for the track element are provided with Type B a-c. relays to hold resistance constant where the track element is called upon to carry comparatively heavy current at low voltage.

The plugboards are bolted to 1/4" by 3/4" steel bars, as described for d-c. relays on page 10.

### D. Test Terminals

Test terminals are provided under a-c. relays in much the same manner as d-c. relays. Details are shown in Catalog Section E Part 31 Plate E3135.

Figure 29 shows the type of terminal that is commonly used on a-c. track relays for shunting the track winding to test operation. Leads from the track winding are connected as shown below. See also Figures 28(a) and (c).

To shunt winding, nut A is turned up tight against strap B. Normally the nut is backed off against the end of the post, which is split and spread to hold nut in the normal position.

The special tool, Figure 48, cannot be used with the shunt type of terminal for taking current readings. A test terminal placed in series with the winding must be used instead. This terminal is similar to the one shown in Figure 29, except that nut A is normally tight against strap B, which is connected to one side of the winding. See Figure 28(d).

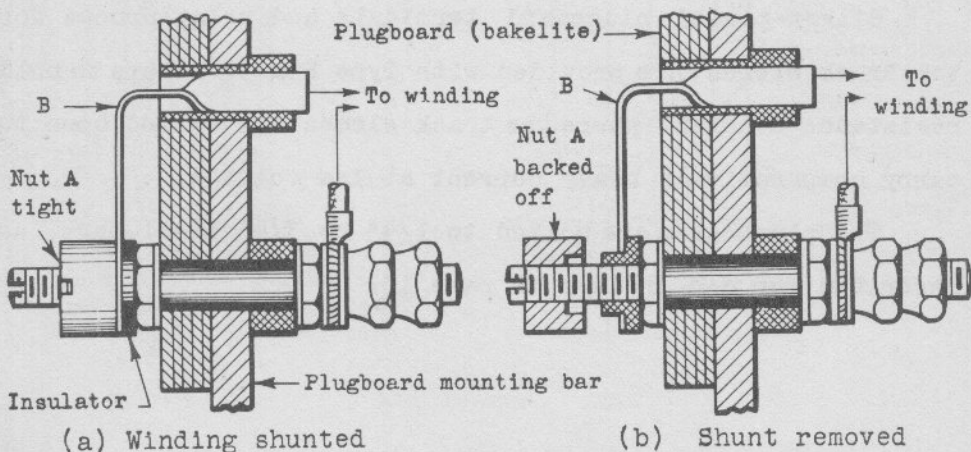

Figure 29. Test terminal for shunting winding

#### IV. THE THERMAL TIME-ELEMENT RELAYS

There are two classes of Type B thermal relays:

- (a) **Class TG** equipped with one normal closed independent and one normal open independent contact. Complete operating cycle of heating and cooling can be varied from 30 seconds to 120 seconds on 10 volts. This relay is illustrated in Figure 30 page 38.
- (b) **Class TJ** having one normal closed independent and one normal open independent contact. Complete operating cycle can be varied from 15 seconds to 30 seconds on 10 volts. This relay is illustrated in Figure 33 page 40.

The timing of the relays can be adjusted in the field by turning a cone-shaped adjusting screw which varies the opening of the normally open contact.

The relays may be used on either alternating or direct current. The timing is not changed as the heating effect is the same in either case.

Relays can be furnished with heater units to operate on either 8, 10, or 12 volts, as required. Variations in the supply voltage make a difference in the operating time. Hence the necessity of maintaining a constant voltage on the heater for best operation.

Relays set for short time operation have a much better voltage regulation than when set for long time operation. If the voltage drops to 65 per cent nominal voltage, the operating time of the relay is not dependable.

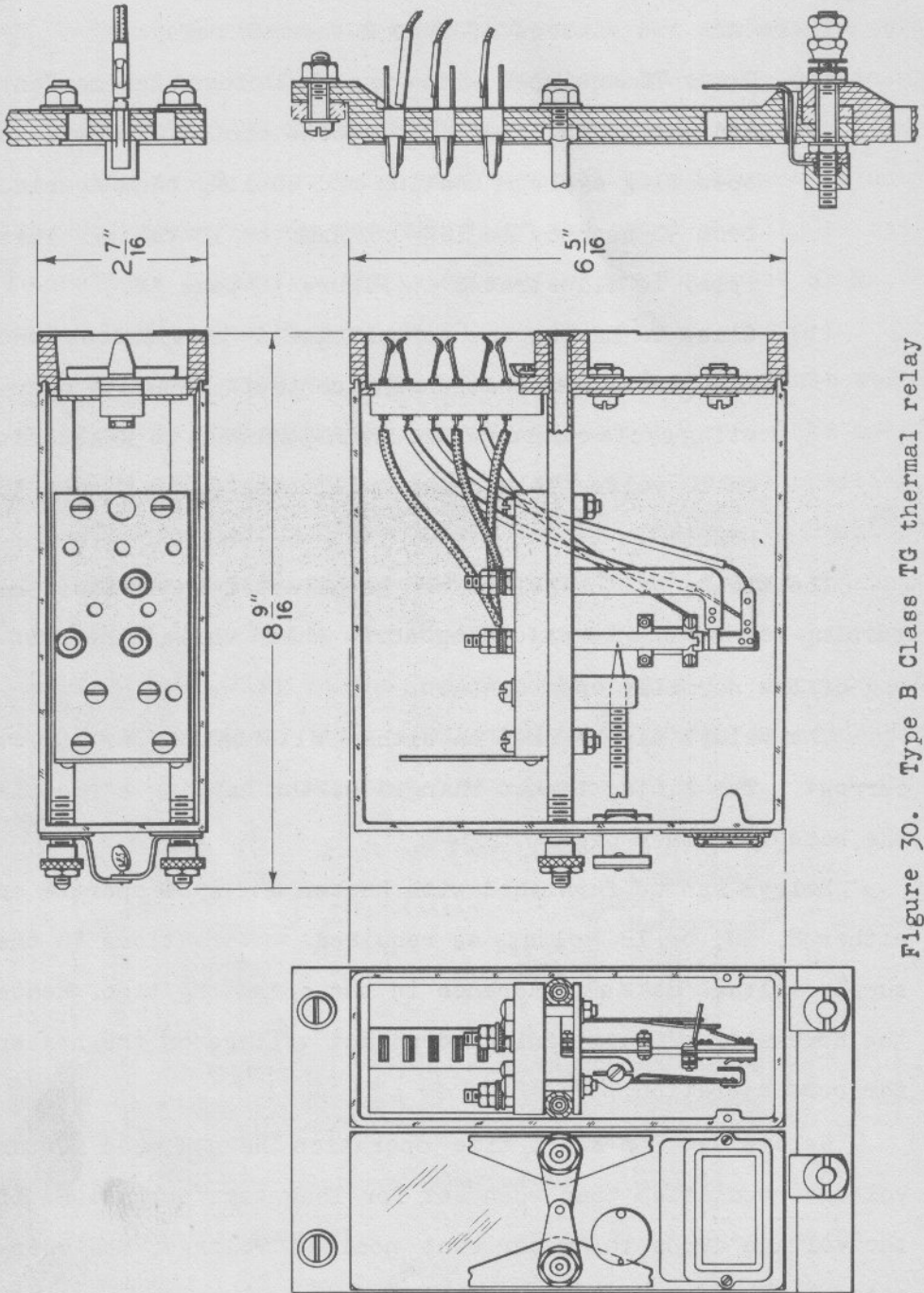

Figure 30. Type B Class TG thermal relay

The contacts are made of silver and have a current-breaking capacity of fifty milliamperes. This should not be exceeded as the arcing becomes excessive because of the inherent slow movement of the contacts.

Both the Class TG and TJ are Size 1 relays and they plug on to standard plugboards.

Both relays are equipped with test terminals and have molded plastic covers. External adjustment is made through an opening in the cover, which opening can be sealed.

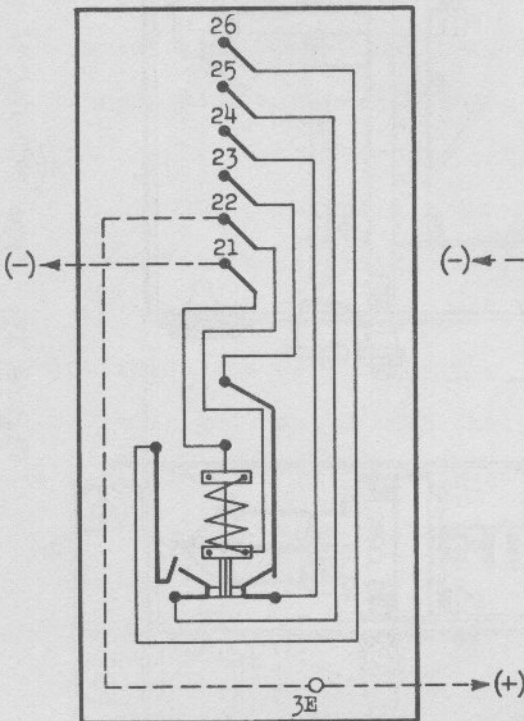

Figure 31. Wiring diagram of Class TG thermal relay

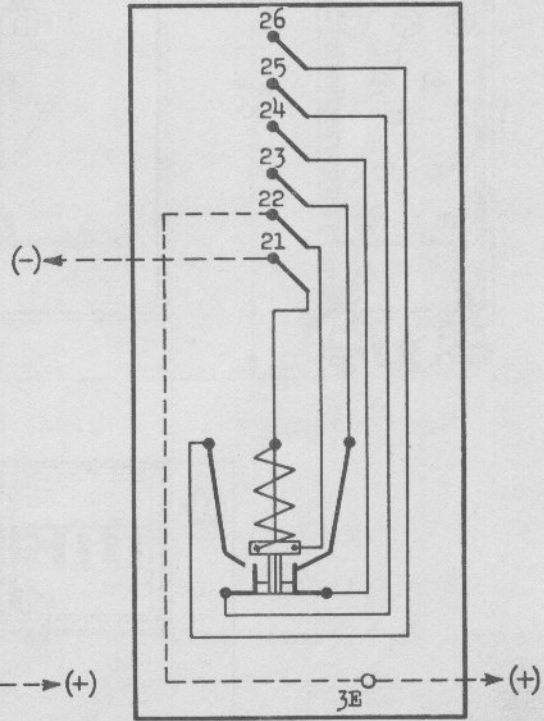

Figure 32. Wiring diagram of Class TJ thermal relay

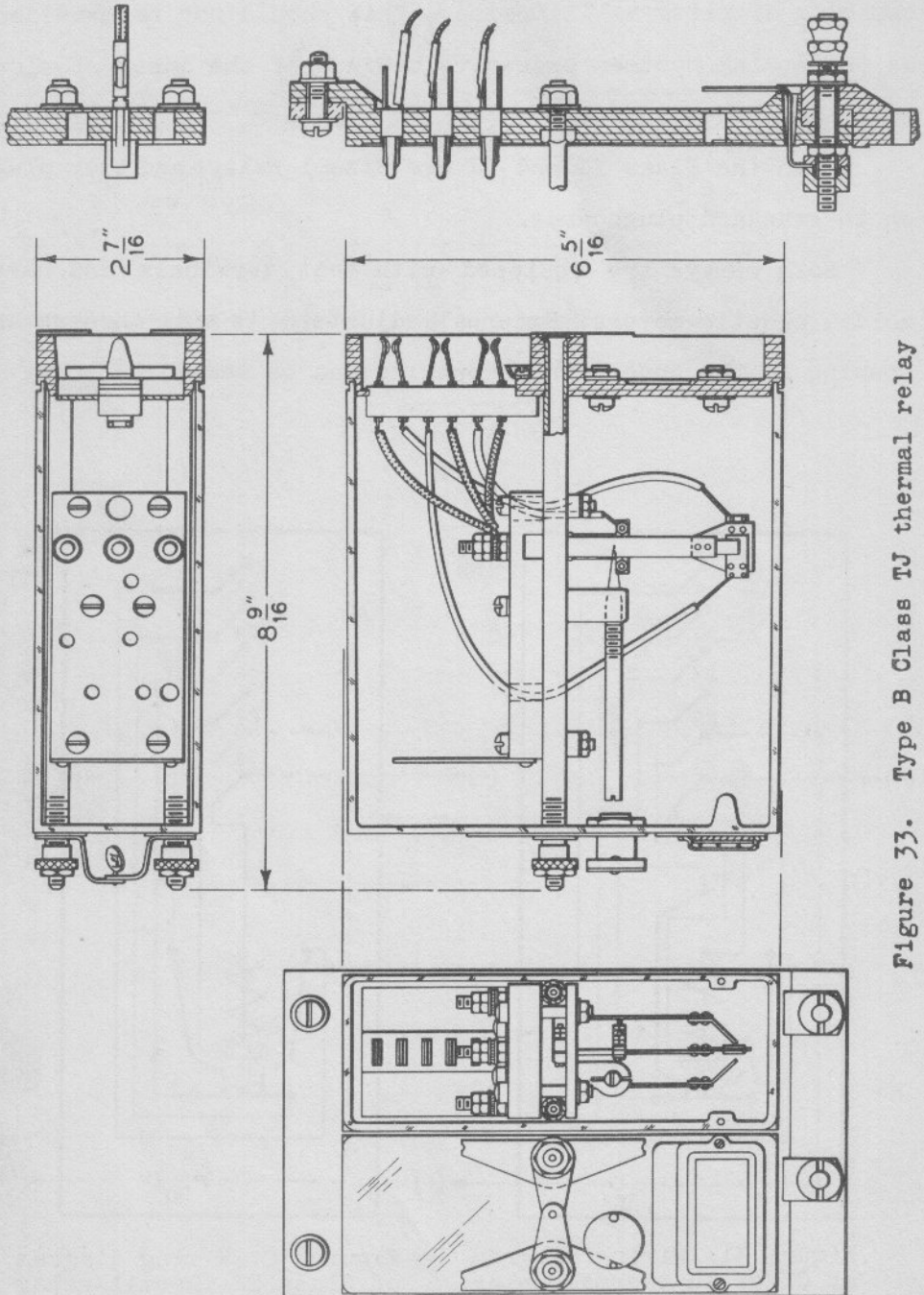

Figure 33. Type B Class TJ thermal relay



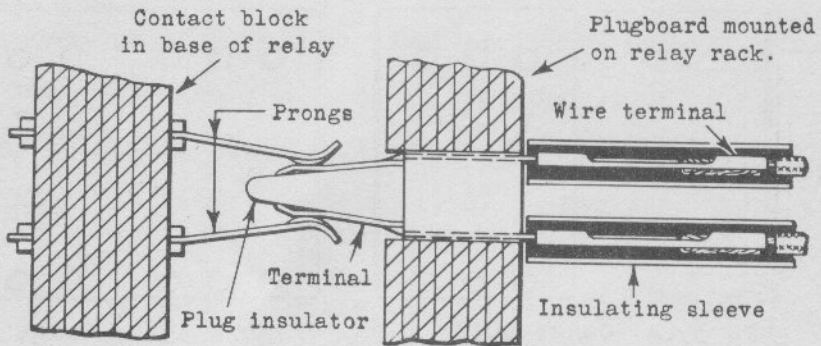

Figure 34. Detail of plug connection.

#### V. QUICK-DETACHABLE FEATURE

All Type B relays are made quick-detachable. The prongs projecting from the contact blocks in the relay base are formed in one piece as a part of the contact spring. The coils in d-c. relays, as mentioned before, have their ends connected to prongs which are assembled on the bakelite spools. When a coil is replaced, the prongs are replaced also.

The plug portion is a part of the plugboard which is mounted on the relay rack, Figure 2. All external wiring is done on the back of the plugboard. The wires are formed into cables which run vertically the length of each section of the relay rack, and fan out into smaller cables which run horizontally to the rows of plugboards.

The individual wires are soldered to wire terminals which are, in turn, soldered to the plugboard terminals; the connection is then covered with an insulating sleeve. This operation is described fully in Section XII. In this section, also, is described the method of inserting plug insulators and terminals into the plugboard when changes are made in the wiring.

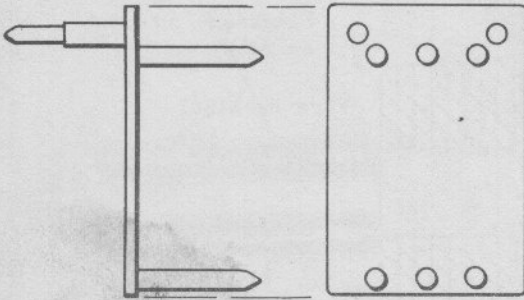

Figure 35(a). Gauge guide for Type B1 relays

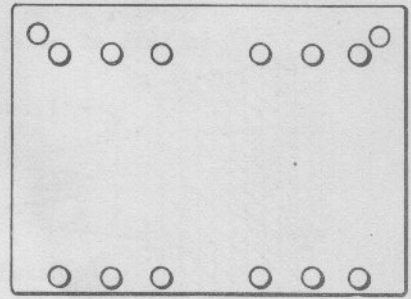
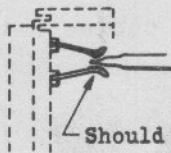
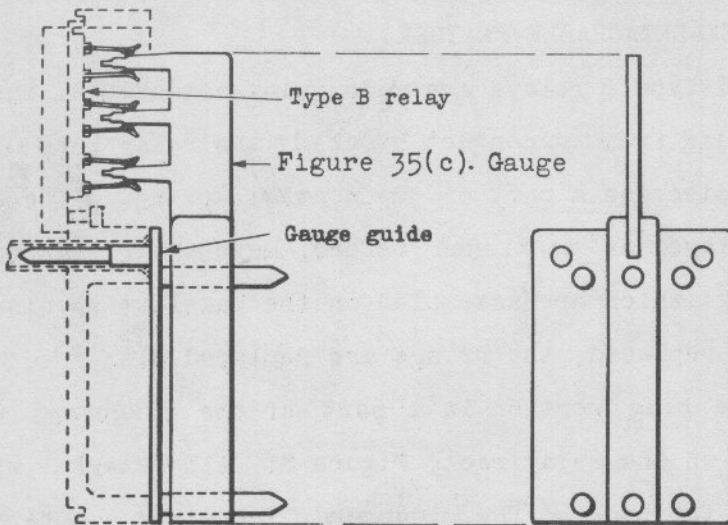
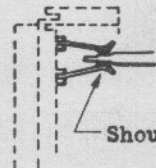

Figure 35(b). Gauge guide for Type B2 relays



Should not touch

.090" Min.  
Prong opening



Should touch

.100" Max.  
Prong opening

Sketches showing gauge and guide arrangement for testing prongs on Type B relays.

Figure 35. Gauge for Type B relays

## VI. INSPECTION

Upon receipt of a shipment of Type B relays, inspect to see that they are clean and in good condition. Such an inspection should include:

1. The relay covers and seal. See that these are not broken.
2. The prongs. While the prongs on the back of the relay that engage with the plugs on the plugboard are clean and are properly adjusted when they leave the factory, there is always the chance that they may become dirty or bent in handling. See that the contacting surfaces are clean, that prongs are so adjusted that they will make good contact when the relay is plugged in place. If prongs are dirty, clean by burnishing. If there is any doubt about the prongs being in proper alignment, use gauges shown in Figures 35(a), 35(b), and 35(c) to check the alignment.

When properly adjusted the prongs should not touch the flat tips on the test plugs. When the gauge plugs are pushed against the prongs, they should noticeably spring out equally on each side of the plugs, enough to insure good contact. Adjust prongs with bending tool, Figure 36.

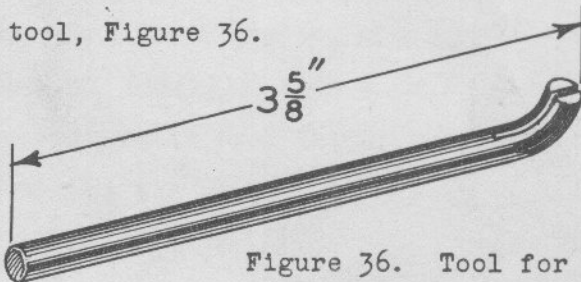

Figure 36. Tool for bending prongs

Should it become necessary to get at the working parts of the relay for any reason, the procedure should be as follows in removing the cover:

1. Break the seal and unscrew the sealing nuts.
2. Remove the cover.

In replacing the cover on relays equipped with flat springs under sealing wing nut:

1. See that the edges fit well all around in the grooves at the base of the relay.
2. Assemble flat springs so as to secure compression on the cover.
3. Screw on the sealing wing nuts until the cover springs are just flat against the cover. Back off the nuts to the first sealing position.
4. Apply seal.

After replacing a cover, inspect relay to insure that suitable clearances exist between cover and all moving parts.

Upon receipt of the relay rack, see that the plugboards are clean, and that the flat contact pieces (terminals), lie close to the plugs. See that the relay supporting rods are not bent and that they are at right angles to the plugboards.

## VII. HOW TO PLUG IN A RELAY

1. Select the proper relay by checking the order reference number on the name plate on the front of the relay against the number painted on the plugboard.
2. Grasping the relay top and bottom with both hands, slide it on to the supporting rods.
3. Press the relay firmly into place so that the back of the relay is snugly up against its plugboard.
4. Hold the relay in this position while putting on the knurled retaining nuts, which should be screwed up only finger-tight. Try to rock the relay. Any freedom here will indicate that the relay is not tight against its plugboard: Press the relay in place and tighten the retaining nuts further with bare fingers.

CAUTION - Do not use the retaining nuts to pull the plugs and prongs into engagement.

5. Screw on the lock nuts, holding the retaining nuts with the fingers to prevent their turning while tightening the lock nuts with a socket wrench.

## VIII. HOW TO REMOVE A RELAY

1. Loosen and remove lock nuts.
2. Loosen and remove knurled retaining nuts.
3. Grasping the relay top and bottom with both hands, rock it slightly from side to side or up and down, to release it from the plug connections.
4. Withdraw the relay.

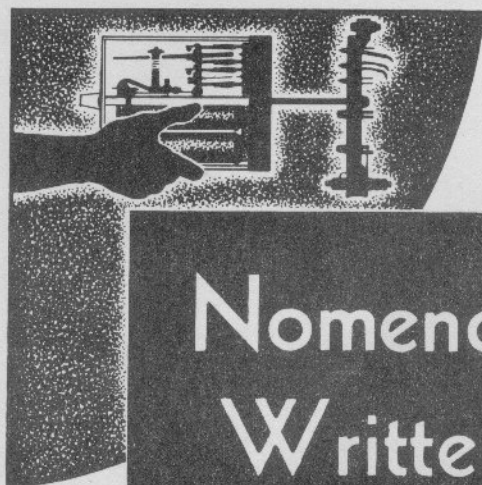

# Nomenclature and Written Circuits

IX. RELAY NOMENCLATURE

When referred to, the **front** of the Type B relay is understood to mean the molded cover surface which carries the relay tag giving test data and the name of the relay.

A. Numbering the Contact Terminals

With the front of the relay nearest the observer, the vertical rows of contacts and their terminals are numbered 1, 2, 3, etc. from left to right. The terminals in each row are numbered from bottom to top. All terminal numbers have two digits. The first digit indicates the row, the second indicates the place the terminal occupies in that row. Thus terminal 36 is in the third row, and is the sixth from the bottom. A terminal in row 1 and in the lowest slot is numbered 11.

Only the contact springs are numbered; the spring stops are not numbered.

B. Numbering the Winding Terminals

Winding terminals have a one-digit number and a letter to identify them. The number is taken from the vertical row in which the terminal is located. The letter denotes its position in that row. Letter A is given to the topmost, letter D to the lowest terminal. Letter E is assigned to the test terminal, described on pages 29 and 36.

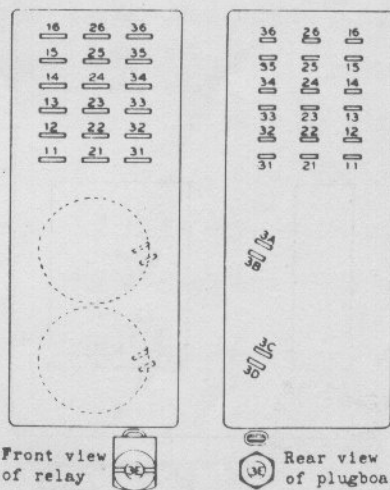
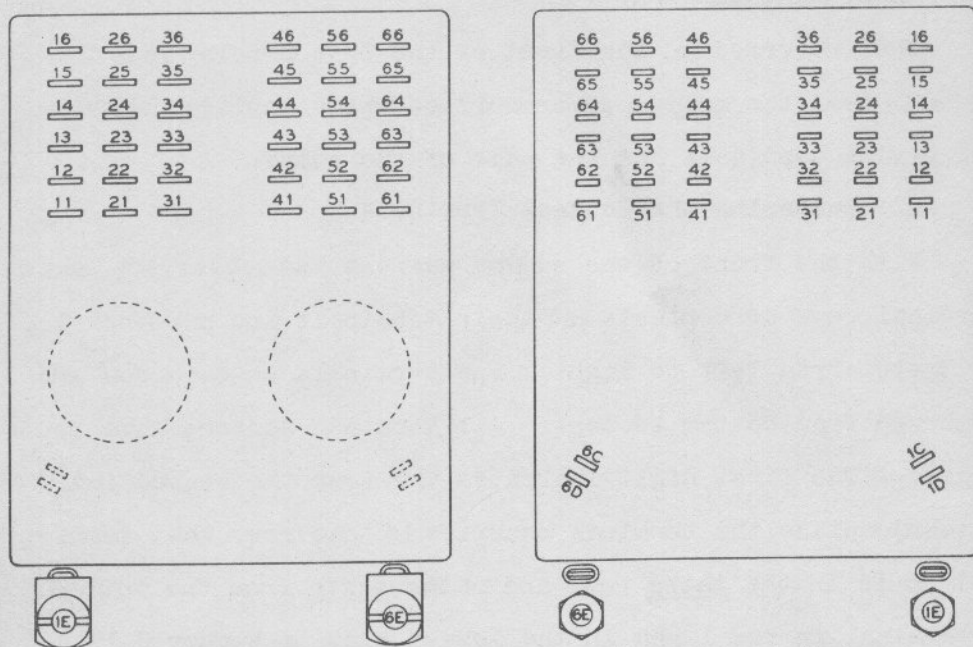

Figure 37. Terminal numbering Type B Size 1 d-c. relays



Front view of relay

Rear view of plugboard

Figure 38. Terminal numbering - Type B Size 2 d-c. relays

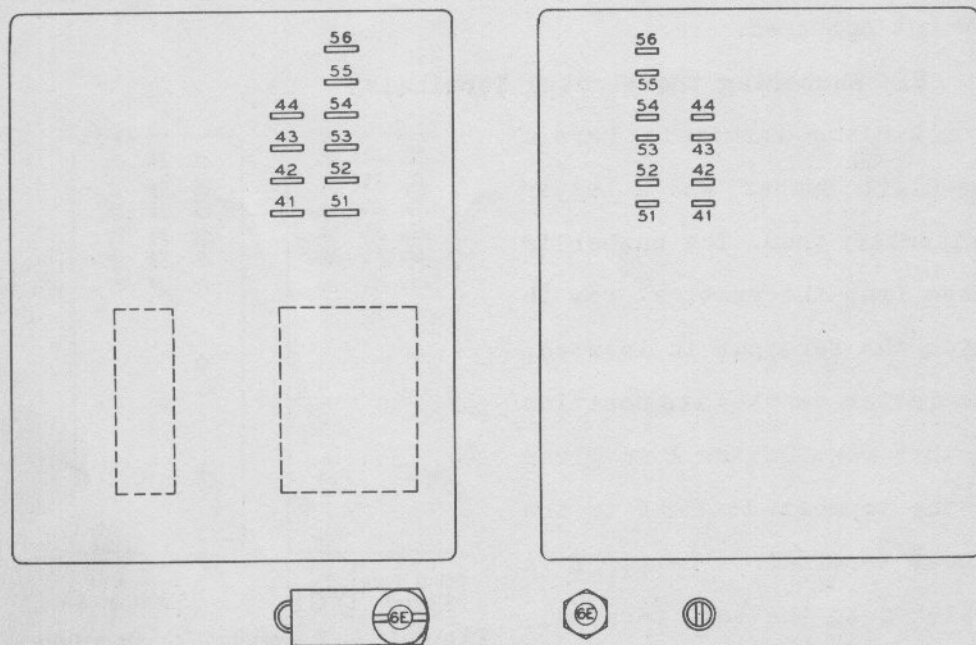

Front view of relay

Rear view of plugboard

Figure 39. Terminal numbering - Type B Size 2 a-c. relays



X. WRITTEN CIRCUITS

A. Contacts

On written circuit plans, a Type B relay's neutral contacts are numbered at the heel, this number being that of the contact spring on the relay which functions as the heel. Thus, in Figure 40, the symbols denote that contact spring 25 on

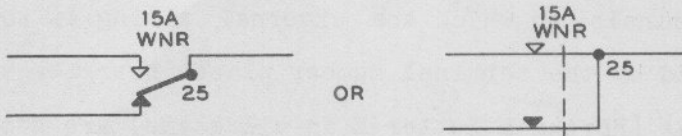

Figure 40. Neutral contact numbering

the 15 AWNR relay, which is the heel in this case, is in row 2 and fifth spring from the bottom. The back contact spring number is 24, although not numbered on the written circuit, as it is below heel spring 25 on the relay. The front contact spring number is 26, being above heel spring 25.

On written circuit plans, a Type B relay's dependent polar contacts have all three parts numbered, the heel, the normal contact, and the reverse contact. Thus, in Figure 41, the symbols denote that the contact spring 65 on the 11WZ relay, which is functioning here as a polar heel, is in the sixth row of contacts, fifth from the bottom. The normal and reverse

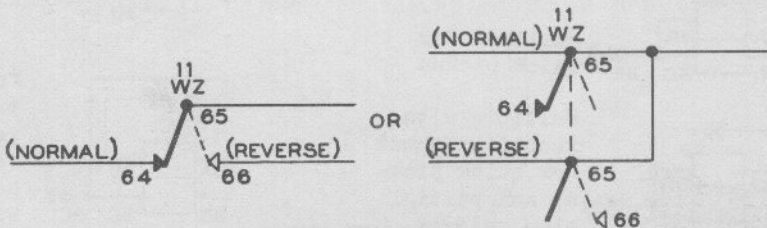

Figure 41. Polar contact numbering

contact springs are respectively below and above it. Note that if the polar contacts are in the first row, the normal and reverse contacts are respectively above and below the polar heel, because of the rocker action of the polar armature.

### B. Windings

On written circuits showing the windings of Type B relays, the terminals to which the external wiring is soldered are indicated by the terminal number placed near its wire. Test terminals (having a letter E in all cases) are shown thus:



-  = circuit through terminal normally closed  
 = circuit through terminal normally open

Figure 42 shows the typical scheme for giving full details of winding connections of Type B Size 1 d-c. neutral relays, in written circuits.

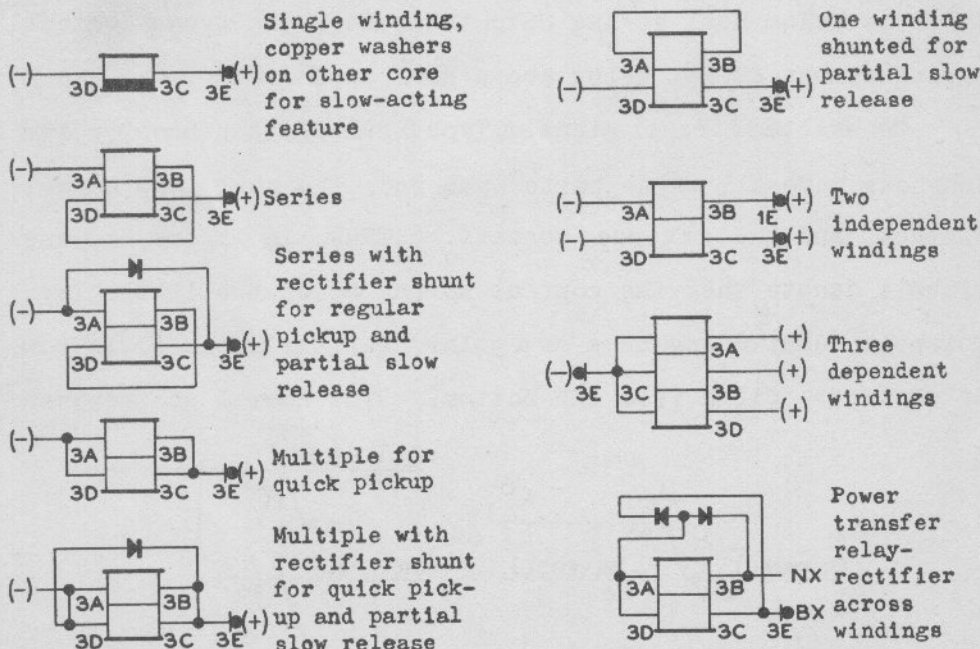

Figure 42. Typical written circuits of Type B Size 1 d-c. neutral relays

Figures 43, 44, 45, and 46 illustrate respectively the written circuits for Size 2 d-c. neutral relays, neutral polar and retained-neutral polar relays, a-c.vane relays, and Size 1 thermal relays.

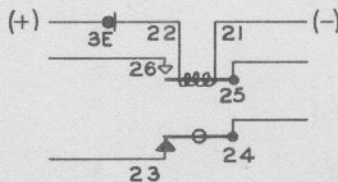
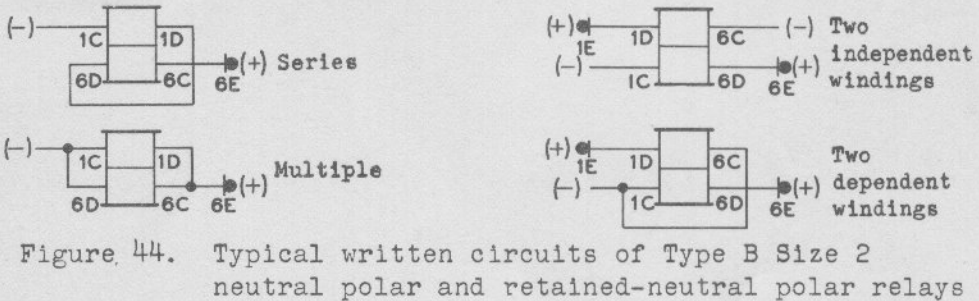
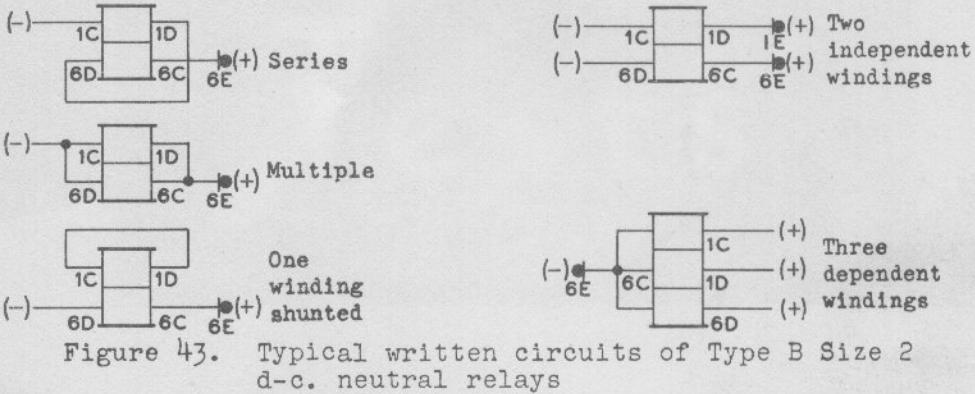
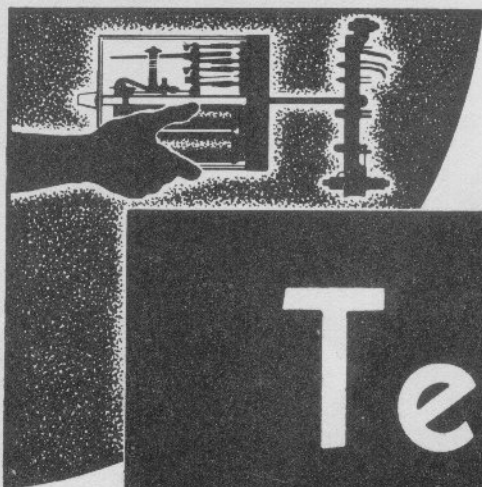

Figure 46. Typical written circuit of Type B thermal relay



# Tests

## XI. TESTS

Tests on Type B relays may be made with the relays on their racks, as in Figures 2, 7, 8, 9, and 10, or the relays may be removed and plugged on relay test rack, Figure 50.

The tests with relays on the relay racks are limited to checking operating values, opening circuits to windings, and shunting track relays.

### A. With Relays on Relay Racks

Test terminals for d-c. and a-c. relays have already been described and illustrated in Figures 22 and 29 respectively. To turn the terminal nut a tool, Figure 47, is available.

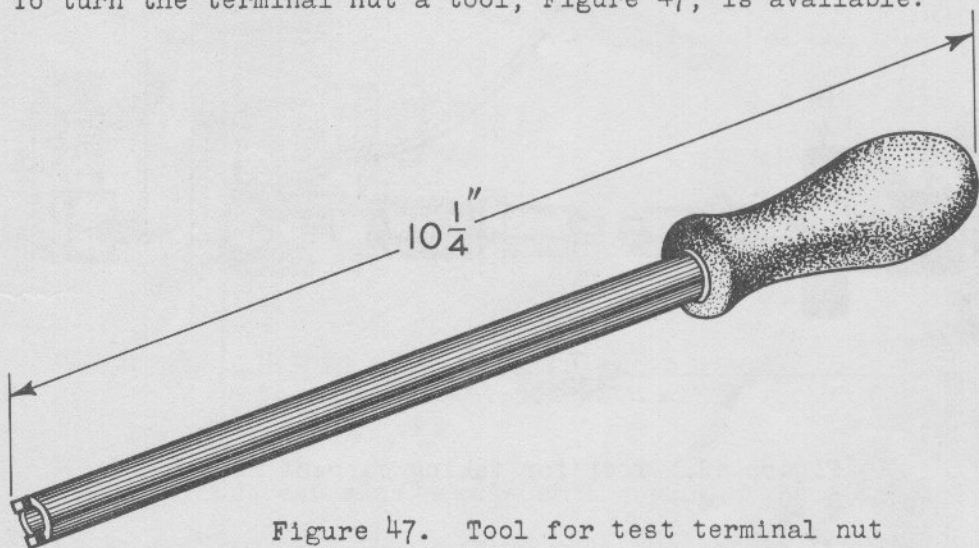

Figure 47. Tool for test terminal nut

In order to read the current flowing through the relay winding, and to vary the current to check operating values with the relay on the relay rack, a tool, Figure 48, is provided. In such tests, of course, the service supply is used and not separate battery.

This tool is attached to the end of terminal post X by pressing nut A with the fingers and turning clockwise as far as it will go. By turning wheel B slowly in either direction, lugs C register with and snap into the slot in round nut Y on the terminal post X. Contact is made at the same time between sleeve D and strap Z.

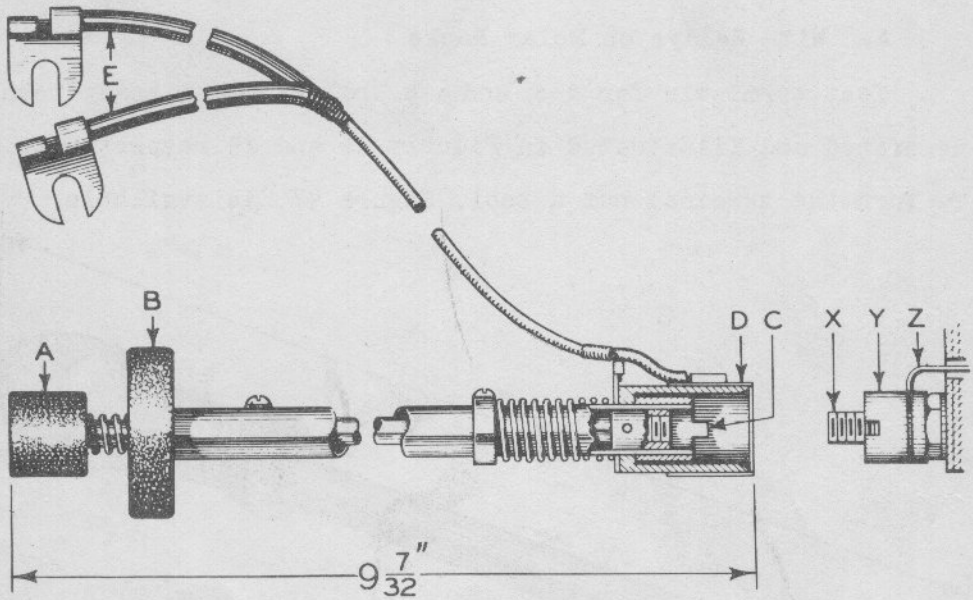

Figure 48. Tool for taking current readings

Turning wheel B counter-clockwise as far as it will go backs up slotted nut Y and puts the winding in series with leads E. These leads can be connected to a meter and a resistance stick in series, the latter being used to vary the current to obtain operating values according to the procedure outlined on the following pages.

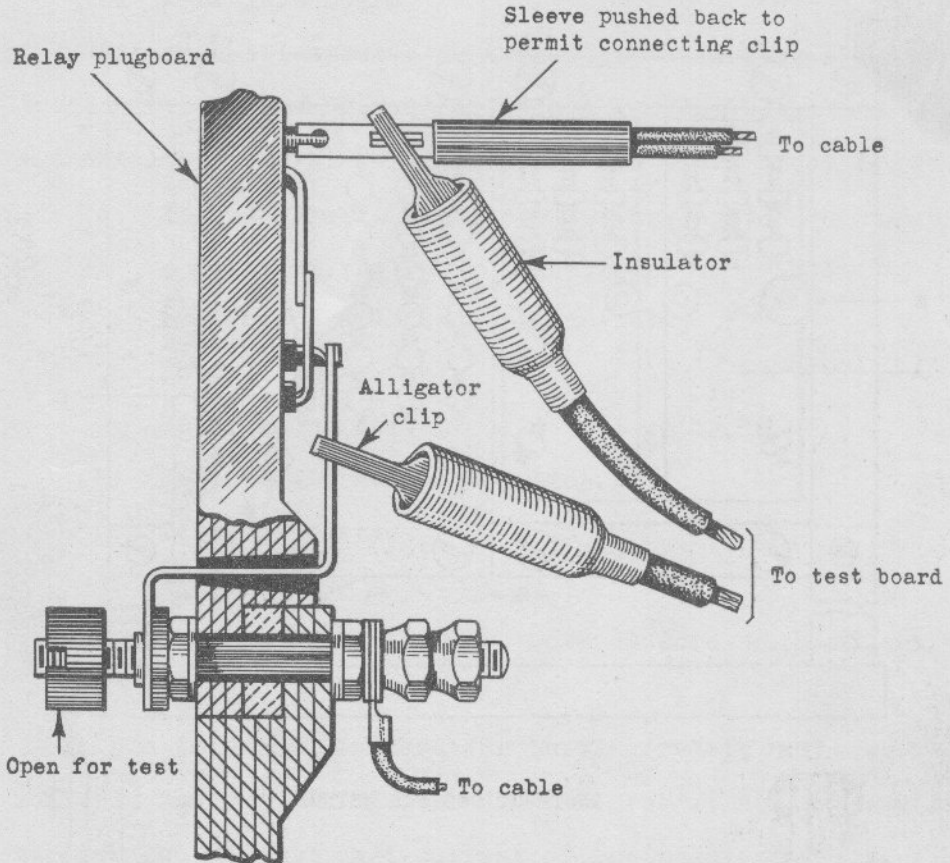
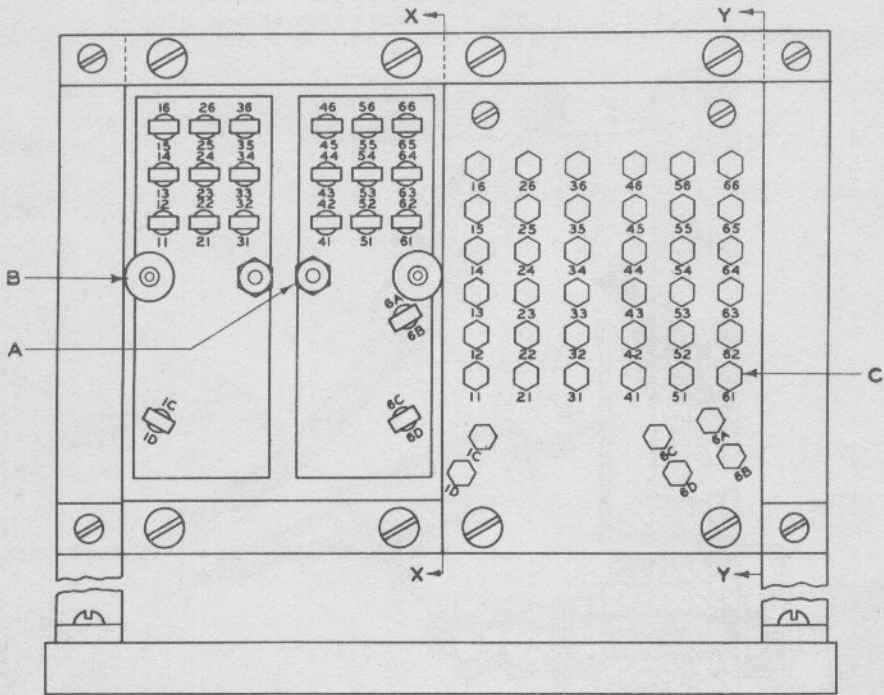

Figure 49. Method of testing relay by using test leads equipped with alligator clips

Connections can also be made on the back of the plugboard as shown in Figure 49, by pushing back the insulating sleeve and exposing the soldered terminal. When tests are completed all sleeves should be replaced properly.

#### B. With Relays on Test Rack

If more elaborate tests are necessary, they should be made by removing the relay from service and plugging it on test rack, Figure 50.



## INSTRUCTIONS FOR USING

1. The relay mounting stud which is removable should be at location B for Type B2 relays.
2. For testing Type B1 relays, the removable mounting stud (referred to above) should be screwed in at location A.
3. Meter test leads should be equipped with alligator clips for connecting to terminal posts C when making tests.

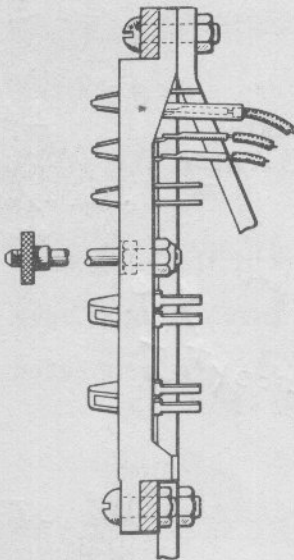

Section X---X

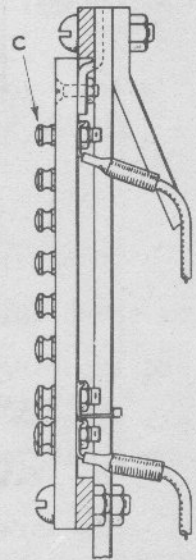

Section Y---Y

Figure 50. Relay test rack



### C. D-c. Test Board

Figure 51 illustrates the test board for making electrical tests on Type B1 and B2 neutral relays and Type B2 neutral polar and retained-neutral polar relays. The board consists of:

1. Two adjustable resistors for varying the voltage and current to the relay under test.
2. Fuse clips and fuses (1 ampere).
3. Polarizing switch.
4. Meter shunt switch.
5. Meter scale selector switch.
6. Terminal posts.
7. Milliammeter, 0-30-300 scale.
8. Two - conductor rubber - covered cord with alligator clips.

When the board is used for testing relays on the service voltage, the circuit gives a series resistance method for varying the voltage and current of the relay. Resistor  $R_s$  gives a coarse wide adjustment,  $R_p$  a fine adjustment to be used near the dropaway, pickup, and working values of the relay.

When the board is used for testing relays on a separate battery, resistor  $R_p$  alone is used, and then as a potentiometer.

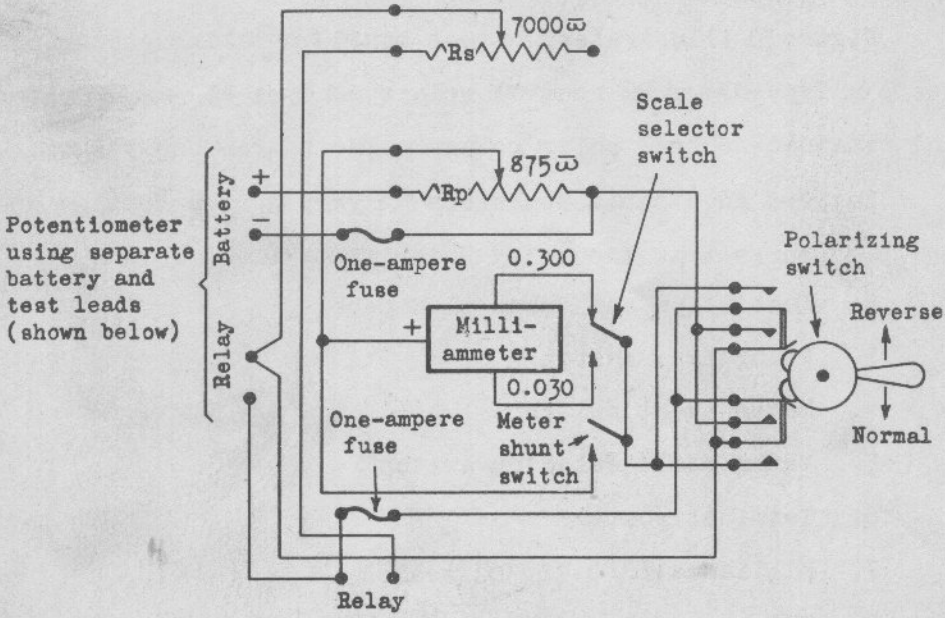

Series using service current and tool, Figure 48.

Wiring diagram of d-c. test board

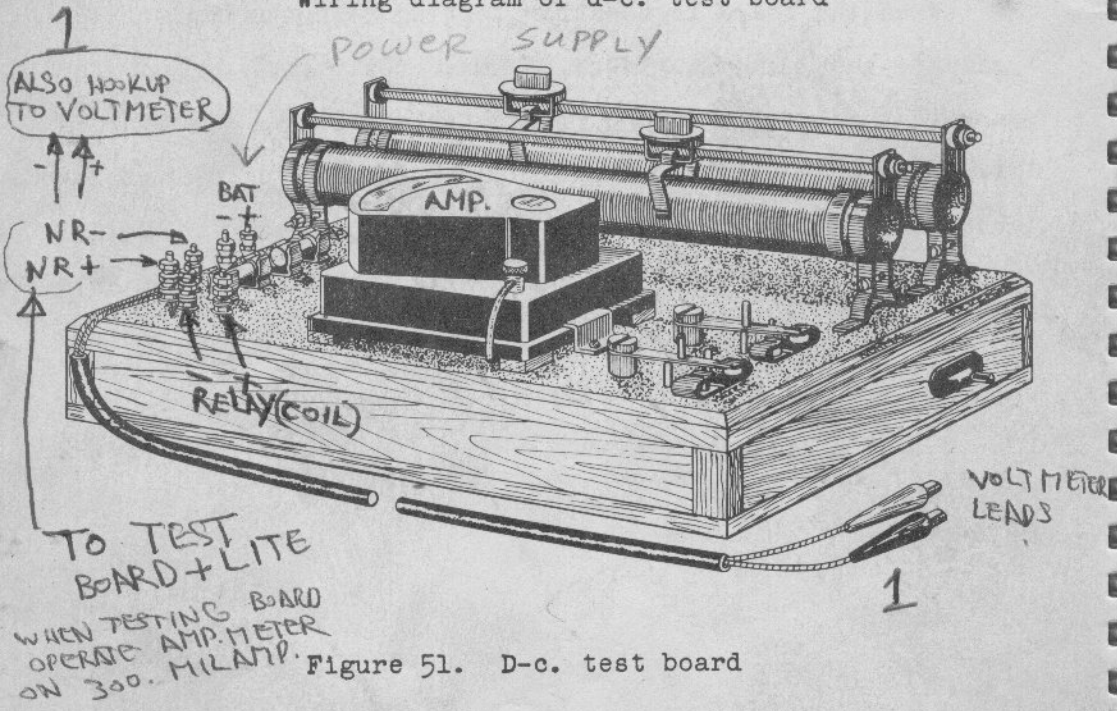
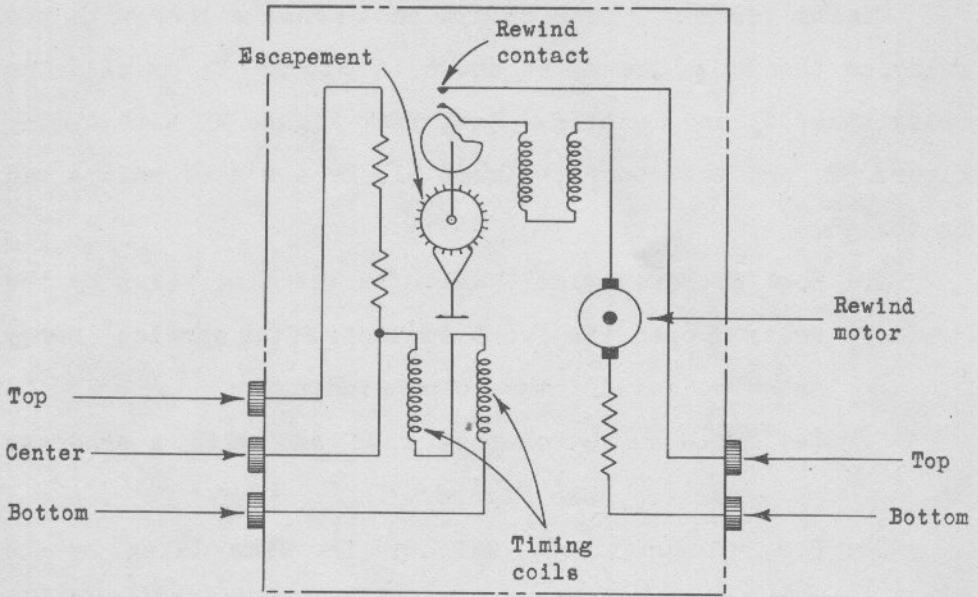

Figure 51. D-c. test board

#### D. Tests for Relay Timing

Timing tests on Type B relays can be made either with the relay on the relay rack, as shown in Figure 2, or with the relay removed, and mounted on test rack Figure 50. With timer, Figure 52, and test board, Figure 51, Type B d-c. relays can be tested.

1. For "dropaway time", which is the time taken by the relay to open its front contacts after service energy has been cut off the relay winding.
  - (a) With relay on test rack and with a separate battery, use Figure 53.
2. For "pickup time", which is the time taken by the relay to close its front contacts after service energy has been applied to the relay winding.
  - (a) With relay on test rack and with a separate battery, use Figure 54(a).
  - (b) With relay on test rack and with a separate battery and potentiometer to give the exact voltage across relay, use Figure 54(b).
3. For time of crossing over of the moving fingers from back contacts to front contacts and vice versa after the service energy has been applied to or cut off the relay winding.
  - (a) With relay on test rack and with a separate battery, use Figure 55(a).
  - (b) With relay on test rack and with a separate battery and potentiometer, use Figure 55(b).



Timer circuit

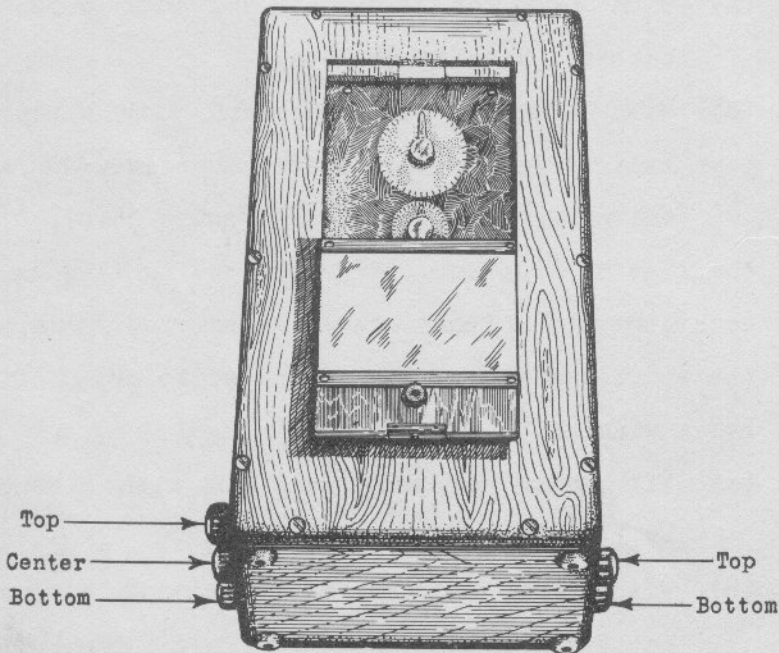

Figure 52. Timer

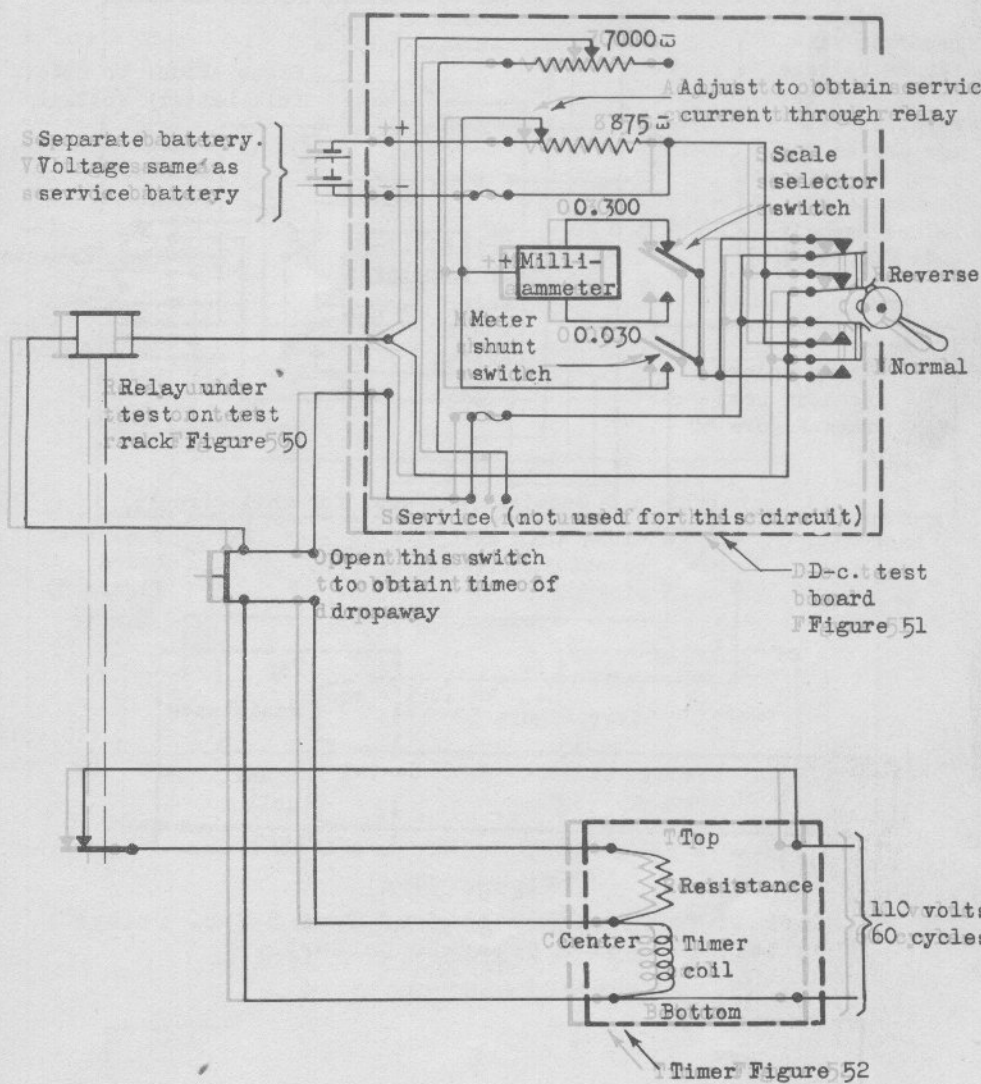

Figure 53

Circuit for timing dropaway of Type BB d-d-c. relays on test track with separate batt

Separate battery. Voltage to be same as service voltage across relay. If this cannot be obtained use circuit Figure 54(b)

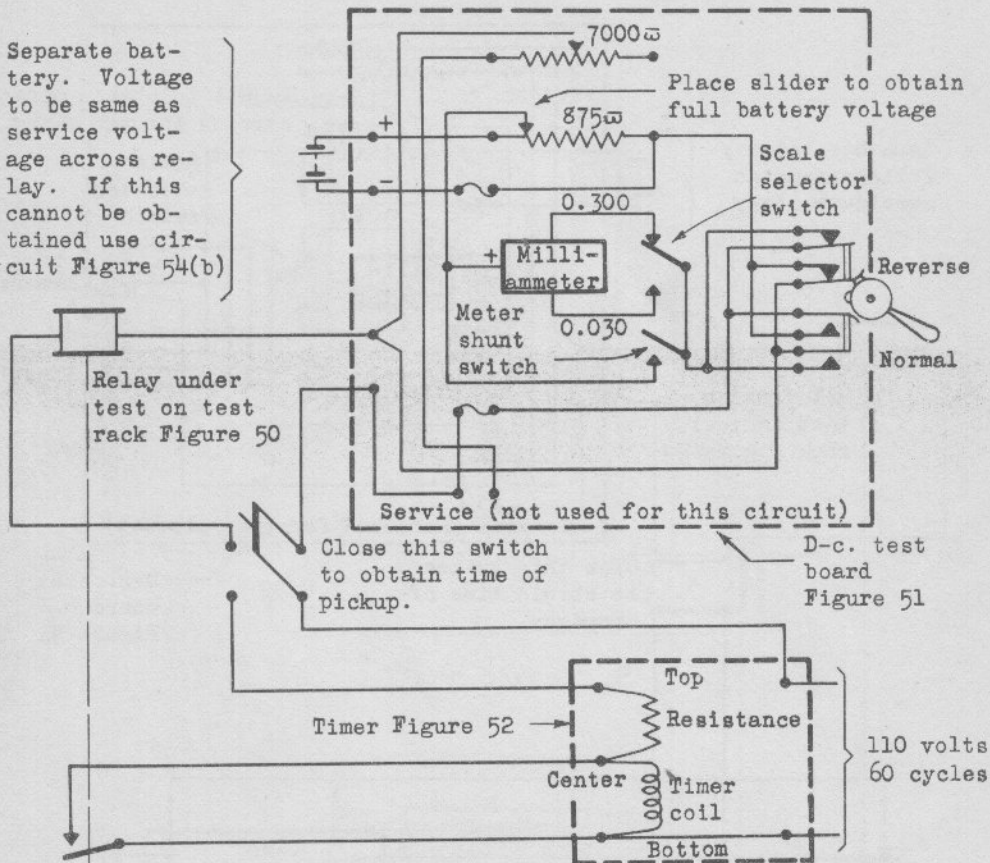
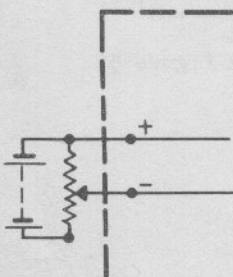

Figure 54(a)

Circuit for timing pickup of Type B d-c. relays on test rack with separate battery



For relays up to and including 4 $\omega$  use 2-volt battery with 0.4 $\omega$  max. res. potentiometer. For relays over 4 $\omega$  use 12-volt battery with 2.75 $\omega$  max. res. potentiometer. See A.A.R. Sig. Sect. Manual Part 137 Section 15.

Figure 54(b)

To obtain exact voltage across the relay, connect this potentiometer circuit to the battery terminals of the test board

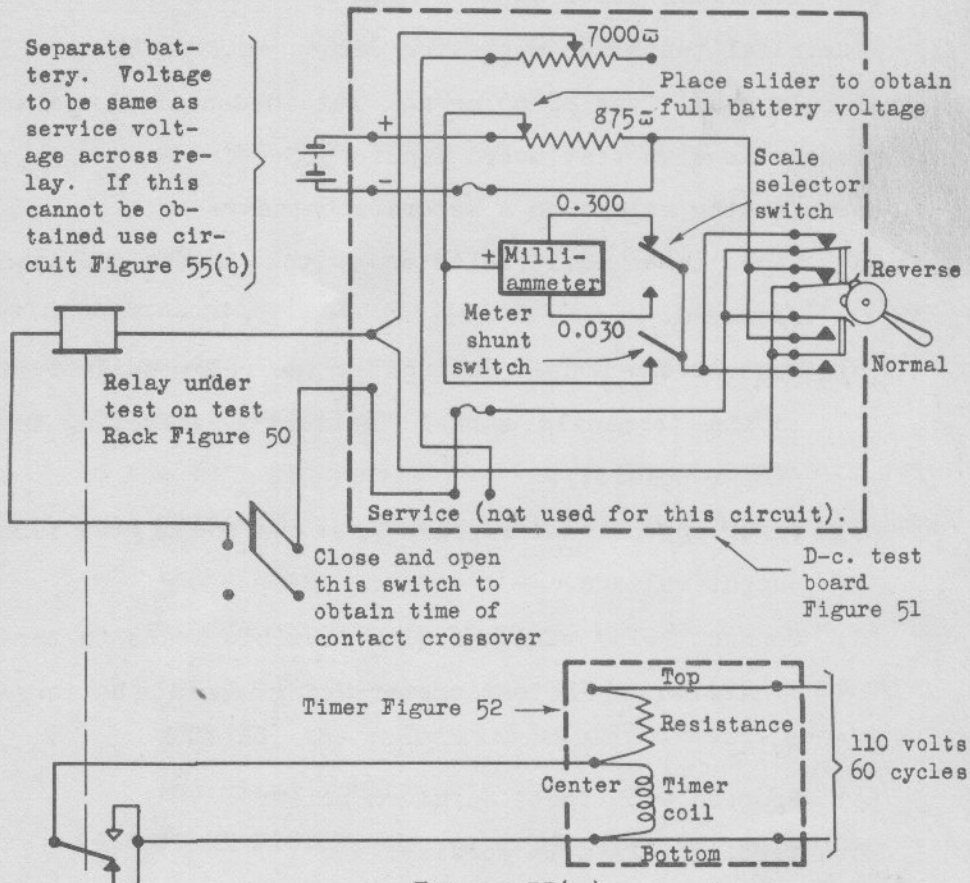

Figure 55(a)

Circuit for timing crossover of contacts of Type B d-c. relays on test rack with separate battery

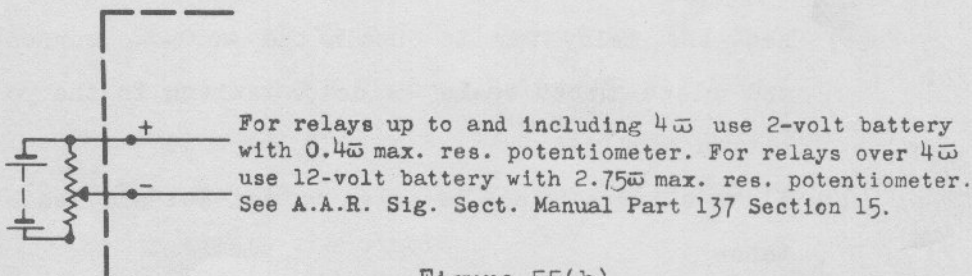

Figure 55(b)

To obtain exact voltage across the relay, connect this potentiometer circuit to the battery terminals of the test board

### E. Electrical Tests on D-c. Relays

Electrical tests for operating values on Type B1 and B2 neutral relays and Type B2 polar and retained-neutral polar relays are made with test board Figure 51.

When testing relays on a separate battery:

- (a) Place meter scale selector switch in the position required.
- (b) Connect the proper voltage for the relay under test to the terminals marked "Battery", selecting the proper polarity.
- (c) Place potentiometer slide  $R_p$  at one end to give zero output voltage.
- (d) Connect relay windings with flexible leads to terminals marked "Potentiometer Using Separate Battery-Relay".
- (e) Proceed with tests as given below.

When testing relays in service:

- (a) Remove all leads from test board.
- (b) Connect leads of tool, Figure 48, to terminals marked "Series Using Service Current-Relay".
- (c) Read the relay tag to obtain the working current and place meter scale selector switch in the position required.
- (d) Place sliders  $R_p$  and  $R_s$  so as to cut out all resistance
- (e) Place polarizing switch in "Normal" position.



- (f) Apply tool to terminal E on relay plugboard and open the relay winding circuit.
- (g) Read the service current.
- (h) Proceed with tests as given below, using service voltage for saturation.

The method of testing relays in service cannot be used with neutral polar and retained-neutral polar relays, except to read the service current or the neutral pickup, working, and dropaway currents.

In the test procedures to follow, these terms are used:

- (a) DROPAWAY, the value at which the neutral back contacts make.
- (b) PICKUP, the value at which the neutral front contacts make.
- (c) WORKING, the value at which the neutral armature is energized against its stop.
- (d) POLAR PICKUP, the value at which the polar contacts make.
- (e) POLAR WORKING, the value at which the polar armature is energized against its stop.

#### 1. Electrical Tests for Operating Values on Type B Sizes 1 and 2 Neutral Relays.

The suggested procedure for obtaining operating values of Type B1 and B2 neutral relays is as follows:

- (a) Saturate the winding.
- (b) Gradually decrease the current to obtain DROPAWAY.

- (c) Open the circuit and close it again.
- (d) Gradually increase the current to obtain PICKUP. Increase the current, if necessary to obtain WORKING.  
NOTE: PICKUP and WORKING will sometimes be identical, depending upon the relay contact loading.

If the relay is equipped with more than one winding repeat the procedure above for each winding. Such a relay should be tested on the relay test rack.

## 2. Electrical Tests for Operating Values on Type B Size 2 Neutral Polar Relays.

The suggested procedure for obtaining operating values of Type B2 neutral polar relays is as follows:

- (a) Saturate the winding, with the relay polar contacts making normal. In the normal polar position, the upper left-hand and lower right-hand polar contacts are closed, with positive energy on the right-hand coil, as viewed from the front of the relay.
- (b) Gradually decrease the current to obtain DROP-AWAY.
- (c) Open the circuit and close it again with the relay polarizing switch, keeping the same polarity on the relay.
- (d) Gradually increase the current to obtain the normal neutral PICKUP. Increase the current further if necessary, to obtain the normal neutral WORKING.  
NOTE: PICKUP and WORKING will sometimes be identical, depending upon the relay contact loading.
- (e) Decrease the current to zero, open and close the circuit by placing the relay polarizing switch reverse.

- (f) Gradually increase the current to obtain the reverse polar PICKUP. Increase the current further if necessary, to obtain the reverse polar WORKING.
- (g) Increase the current still further to obtain the reverse neutral PICKUP.
- (h) Increase the current further, if necessary, to obtain the reverse neutral WORKING.
- (i) Saturate the winding with the polar contacts making reverse.
- (j) Gradually decrease the current to zero.
- (k) Open and close the circuit by placing the relay polarizing switch normal.
- (l) Gradually increase the current to obtain the normal polar PICKUP. Increase the current further, if necessary, to obtain the normal polar WORKING.

### 3. Electrical Tests for Operating Values on Type B Size 2 Retained-Neutral Polar Relays.

The tests used for Type B2 neutral polar relays apply to Type B2 retained-neutral polar relays. In addition, retained-neutral polar relays must be tested for retaining the neutral armature as follows:

- (a) Connect the Type B2 retained-neutral polar relay in such a way that it is pole-changed through a controlling relay's contacts.
- (b) Neutral armature of retained-neutral polar relay must be retained in the energized position when the relay is pole-changed at service voltage by its controlling relay.

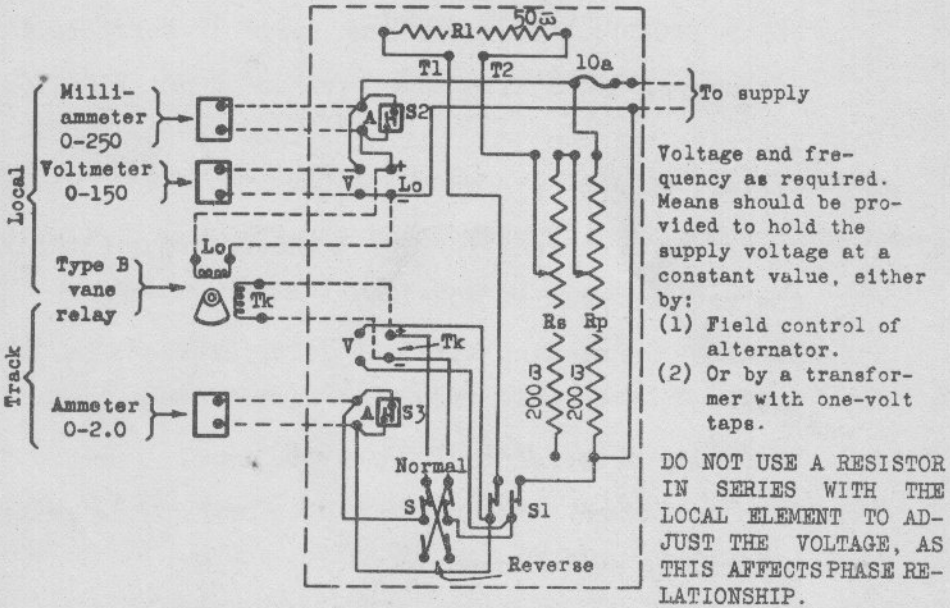

Wiring diagram of a-c. test board.

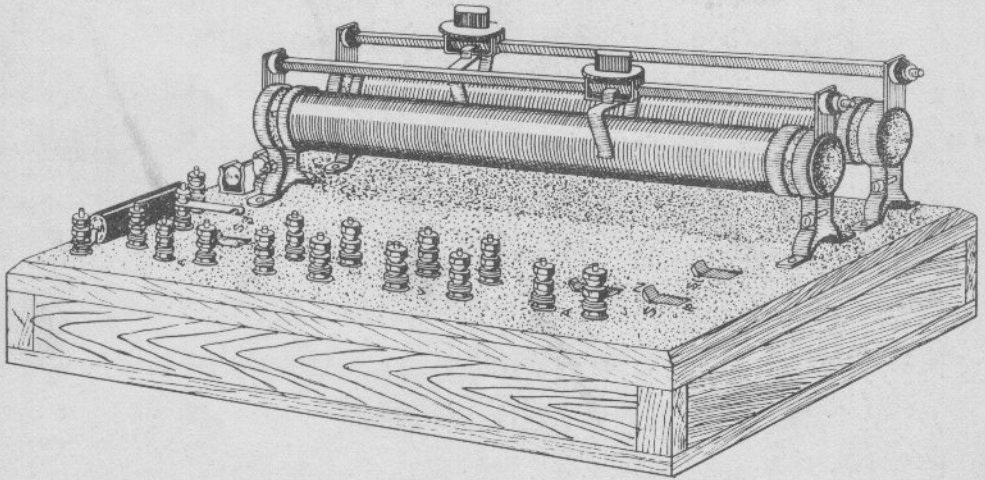

Figure 56. A-c. test board

#### F. A-c. Test Board

Electrical tests for operating values on Type B2 vane relays are made with test board, Figure 56. The board consists of:

1. Two non-inductive adjustable resistors for varying the voltage and current in the controlled element of the relay, to obtain the dropaway, pickup, and working values. These resistors,  $R_s$  and  $R_p$ , each of 200 ohms non-inductive resistance, are designed to carry 1.4 amperes continuously.
2. One 50-ohm fixed resistance unit  $R_1$  designed to carry 1.4 amperes continuously.
3. Fuse clips and 10-ampere fuse.
4. Pole-changing switch  $S$ .
5. Track element switch  $S_1$ .
6. Short circuiting switches  $S_2$ ,  $S_3$ .
7. Short circuiting terminal posts  $T_1$ ,  $T_2$ .

The circuit gives a combined potentiometer and series resistance method for varying the voltage and current to the controlled element of the relay under test.  $R_p$  is connected directly across the supply line as a potentiometer.  $R_s$  is connected as a variable series resistance.  $R_p$  gives a coarse wide range adjustment, and  $R_s$  gives a fine adjustment, to be used near the dropaway, pickup, and working values of the relay.

R1 is a fixed series resistance used when testing track relays, so that there is never less than 50 ohms in series with the track element of the relay. This insures that the power factor of the track element circuit is nearly unity, thereby assuring accurate and comparative test results. The values obtained are at the inherent phase angle of the relay. This resistor also protects the meters and variable resistors.

When a-c. line or single element relays are to be tested, resistor R1 should be shunted by connecting a jumper from terminal T1 to T2.

PRECAUTIONS to be observed when using test board:

1. When using the resistance test board to obtain drop-away, pickup, and working values of a relay, always move the adjustable resistances  $R_p$  and  $R_s$  slowly, when approaching and when at these values, since the values will vary depending upon whether the voltage and current to the controlled element is varied rapidly or slowly. By varying these resistances at a slow gradual rate, it is easier to detect any erratic behavior in the operation of a relay.
2. Be sure to allow for the voltage drop in the ammeter when taking local element current readings.
3. When obtaining values of dropaway, pickup, and working current, keep the voltmeter in the circuit across the local element, cut out the local ammeter, and omit the voltmeter across the controlled element.

### G. Electrical Tests on A-c. Relays.

#### 1. Electrical Tests for Operating Values on Type B Two-Position Vane Relays.

In testing two-element two-position a-c. vane relays:

- (a) Connect the relay and instruments to the resistance test board as shown in circuit, Figure 56. The voltage and frequency of the supply is to be at the rated values for the local element.
- (b) Obtain the local element current reading as required in the specification of the relay under test. See "Precautions 2".
- (c) Shunt out the local ammeter with switch S2 and re-adjust the local element voltage so that the rated voltage is impressed across the local element terminals. Hold constant during test.
- (d) Vary the controlled element current by resistances  $R_p$  and  $R_s$  and obtain the dropaway, pickup, and working values as described for the d-c. neutral relays.
- (e) The operating current of the relay must be within the limits specified.
- (f) The dropaway percentage should be above the minimum specified.

All two-element track relays should be checked for polarity as follows:

- (a) Be sure that the positive terminals on the local and controlled phase windings are connected to the positive posts on the local and controlled phase terminals of the test board as marked.
- (b) When so connected and with the pole-changing switch thrown in the normal position, the relay must close its normal or front contact.

## 2. Electrical Tests for Operating Values on Type B Three-Position Vane Relays.

- (a) With pole-changing switch S in the normal position, make tests given on page 75, Section G1.
- (b) With pole-changing switch S in the reverse position, make tests given on page 75, Section G1.

## H. Electrical Tests on Thermal Relays

In testing Type B thermal relays for timing, the circuit shown in Figure 57 should be used.

In any event a contact of a repeater relay must be connected in the heating circuit of the thermal relay to cut off the full supply voltage from the heater unit after the normally open contact has closed. Otherwise the bimetallic thermal strip may be damaged and bent out of adjustment.

A period of ten minutes must elapse between consecutive tests on any one relay to allow it to cool to room temperature. All tests should be made with service voltage impressed across the heater unit.



The following timings may be obtained with the circuit illustrated in Figure 57:

1. To check heating time, close switch A; measure the time that elapses from the closing of switch A to the lighting of light C. This, incidentally, is the time it takes for the normally open contacts to close.
2. To check cooling time; measure the time that elapses from the lighting of light C to the lighting of light B.
3. The time of the complete heating and cooling cycle is the sum of the times recorded in 1 and 2 above.

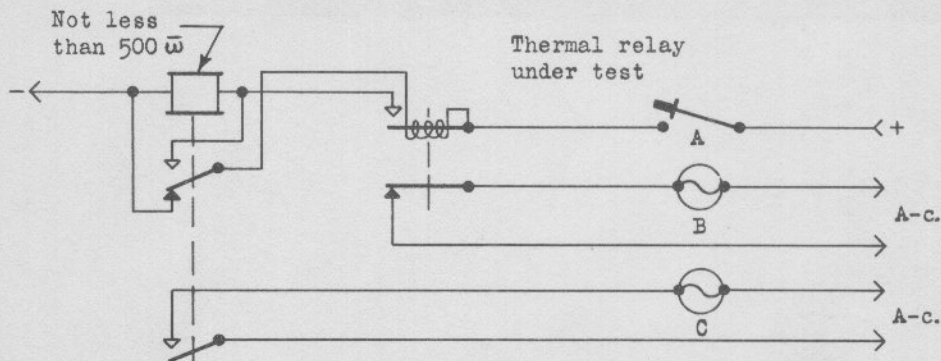

Figure 57. Circuit for timing Type B thermal relays

#### J. Contact Resistance.

Measure the contact resistance. Cleaned contact resistance:

1. Silver-impregnated carbon to silver should be not more than 0.04 ohm.
2. Silver to silver 0.02 ohm.

Abrasives and cleaning fluids must not be used on contacts. Contacts should be cleaned by using white bond paper, or sand-blasted feeler.



# Wiring Changes, Tools and Supplies

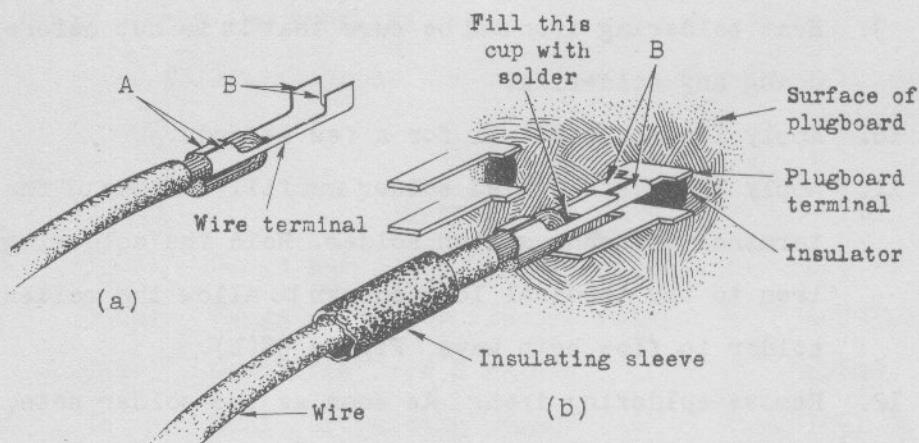

Figure 58. Plugboard wiring

## XII. SUGGESTIONS WHEN CHANGING PLUGBOARD WIRING

When changes in wiring are to be made in the field, the following suggested procedure may be found helpful in soldering the new wires to the plugboard terminals:

1. Find out from the circuit plans to which terminal the wire must be soldered, and ring out to check.
2. Expose 1/2 inch of bare wire.
3. If a single wire, twist strands together; if two wires, twist them both together.
4. Feed the wire through the round hole in the wire terminal and squeeze ears "A" tight against the wire. Bend the end of the wire so that it lies snug against the terminal, Figure 58(a).
5. Bend ears "B" slightly thus:  $\triangleleft$
6. Slide insulating sleeve over terminal and on to wire. For size of sleeve to be used, see page 85.
7. Slide terminal on plugboard terminal.
8. Squeeze ears "B" tight against plugboard terminal.

9. Heat soldering iron and be sure that it is hot before doing any soldering.
10. Apply iron to terminal for a few seconds.
11. Apply the rosin-filled solder and fill the cup of the terminal with the molten solder. Hold the soldering iron to the terminal long enough to allow the molten solder to flow both ways, Figure 58(b).
12. Remove soldering iron. As soon as the solder sets, pull wire to check that joint is properly soldered.
13. Apply asphalt paint to the exposed metal parts where protection against moisture and acids is desired.
14. Slide insulating sleeve over terminal and against plugboard.

Should it be necessary to add terminals to plugboards, proceed as follows:

1. Break the thin bakelite flashing across the plugboard hole with a punch.
2. Hold a plugboard terminal on each side of the plug insulator, and insert in hole. Drive into place.
3. Straighten ears A. Figure 59, shows complete assembly.
4. Change ordering numbering of relay on plugboard, if necessary.

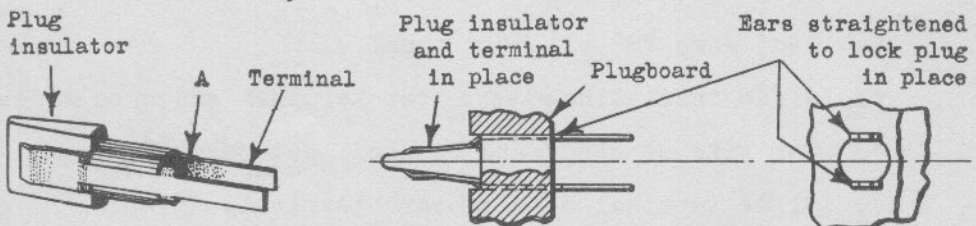

Figure 59. Plug and terminal assembly

XIII. TOOLS AND SUPPLIES

The following tools are recommended for the maintenance of Type B relays:

See Figure	Description	Ordering Reference
35(a)	Gauge guide for Type B1 relays	56260-8
35(b)	Gauge guide for Type B2 relays	56260-10
35(c)	Gauge for Type B relays	56260-9
36	Tool for bending prongs	47951-28
47	Tool for opening coil circuit	55392-1 Gr 1
48	Tool for taking current readings	56622 Gr 2
	Meter leads equipped with:	
49	Alligator clips	56276
49	Rubber insulator, red	56277
49	Rubber insulator, black	56277-1
50	Test rack for Type B relays	56573 Gr 1
51	Test board for Type B d-c. relays	56647 Gr 1
52	Timer, (cycle counter), 110-volt 60-cycle	56847
56	Test board for Type B a-c. relays	56647-2 Gr 1
	Meters:	
	d-c. milliammeter, 0-30-300 scale	
	d-c. voltmeter, 0-3-15 scale	
	a-c. milliammeter, 0-250 scale	
	a-c. ammeter, 0-2 scale	
	a-c. voltmeter, 0-1.5-15-150 scale	

See Figure	Description	Ordering Reference
	Sand-blasted feeler for cleaning relay contacts	55411-3
	Wire stripper	56852
	Electric soldering iron, 110-volt, 95-watt	55408

The following supplies are recommended for the maintenance of Type B relays:

See Figure	Description	Ordering Reference
58	Flexible copper wire, single conductor, 1/32" wall superaging rubber insulation, single green cotton braid, lacquer coated	MS2-134

<u>Size (AWG)</u>	<u>Outside diameter</u>
10	0.216"
12	0.194"
14	0.175"
16	0.159"

58	Flexible copper wire, single conductor, 1/32" wall superaging rubber insulation, single green cotton braid, flame retarding	MS2-143
----	---	---------

<u>Size (AWG)</u>	<u>Outside diameter</u>
10	0.217"
12	0.195"
14	0.176"
16	0.160"

Specify type, size, and length of wire required.

See Figure	Description	Ordering Reference
58	Sleeve, insulating, 5mm. (0.197") inside dia. for one No. 12 or No. 14 or No.16 AWG wire (MS2-134 or -143)	55557
58	Sleeve, insulating, 6mm. (0.236") inside dia. for one No. 10 AWG wire (MS2-134 or -143)	55557-2
58	Sleeve, insulating, 7mm. (0.276") inside dia. for two No.16 AWG wires (MS2-134 or -143)	55557-4
58	Wire terminal	55083-12
59	Plug insulator	55862-3
59	Plug terminal	55871-5
59	Plugboard	56022
	Rosin-filled solder	MS2-118
	Asphalt paint for resisting moisture, acids, etc.	MS2-145
	Friction tape 1/2" wide	

Ordering references for other plugboard parts are given in Catalog Section E Part 31 Plate E 3135.

DISTRICT OFFICES

NEW YORK OFFICE

230 Park Avenue, New York, New York

CHICAGO OFFICE

122 South Michigan Avenue, Chicago, Illinois

ST. LOUIS OFFICE

611 Olive Street, St. Louis, Missouri



